

Pioneer

AVH-3500NEX

DVD RDS AV RECEIVER

English



pandora®

Operation Manual

Important (Serial number)

The serial number is located on the bottom of this unit. For your own security and convenience, be sure to record this number on the enclosed warranty card.

Contents

Thank you for buying this Pioneer product.
Please read through these instructions so you will know how to operate your model properly. After you have finished reading the instructions, keep this document in a safe place for future reference.

Important

The screen shown in the examples may differ from actual screens, which may be changed without notice for performance and function improvements.

■ Precaution	4
■ Parts and controls	12
■ Basic operation	15
■ Bluetooth	24
■ AV source	33
■ Radio	36
■ Disc	39
■ Compressed files	44
■ iPod®	52
■ WebLink™	56
■ Apple CarPlay™	59
■ Android Auto™	62
■ Pandora®	65
■ Spotify®	68
■ SiriusXM® Satellite Radio	73
■ AUX	81
■ AV input	83
■ Settings	84
Displaying the setting screen	84
System settings	84

Theme settings.....	92
Audio settings	93
Video settings	100
Favorite menu	104
Other functions.....	105
Appendix	107

Precaution

Information to user

-MODEL NO.: AVH-3500NEX
FCC ID: EW4C95
IC: 4250A-C95

- This device complies with Part 15 of FCC Rules and Innovation, Science, and Economic Development Canada licence-exempt RSSs. Operation is subject to the following two conditions: (1) this device may not cause interference, and (2) this device must accept any interference, including interference that may cause undesired operation of this device.
- The Bluetooth antenna cannot be removed (or replaced) by user.
- This equipment complies with FCC/ISED radiation exposure limits set forth for an uncontrolled environment and meets the FCC radio frequency (RF) Exposure Guidelines and RSS-102 of the ISED radio frequency (RF) Exposure rules. This equipment has very low levels of RF energy that it deemed to comply without maximum permissive exposure evaluation (MPE). But it is desirable that it should be installed and operated keeping the radiator at least 20 cm or more away from person's body (excluding extremities: hands, wrists, feet and ankles).

- This transmitter must not be co-located or operated in conjunction with any other antenna or transmitter.
- Alteration or modifications carried out without appropriate authorization may invalidate the user's right to operate the equipment.
- NOTE: This equipment has been tested and found to comply with the limits for a Class B digital device, pursuant to Part 15 of the FCC Rules. These limits are designed to provide reasonable protection against harmful interference in a residential installation. This equipment generates, uses and can radiate radio frequency energy and, if not installed and used in accordance with the instructions, may cause harmful interference to radio communications. However, there is no guarantee that interference will not occur in a particular installation. If this equipment does cause harmful interference to radio or television reception, which can be determined by turning the equipment off and on, the user is encouraged to try to correct the interference by one or more of the following measures:
 - Reorient or relocate the receiving antenna.
 - Increase the separation between the equipment and receiver.
 - Connect the equipment into an outlet on a circuit different from that to which the receiver is connected.
 - Consult the dealer or an experienced radio/TV technician for help.

CAUTION:

USE OF CONTROL OR ADJUSTMENT OR PERFORMANCE OF PROCEDURES OTHER THAN THOSE SPECIFIED HEREIN MAY RESULT IN HAZARDOUS RADIATION EXPOSURE.

CAUTION:

THE USE OF OPTICAL INSTRUMENTS WITH THIS PRODUCT WILL INCREASE EYE HAZARD.

CAUTION

This product is a Class 1 laser product classified under the safety standard, IEC 60825-1:2014.

CLASS 1 LASER PRODUCT

FEDERAL COMMUNICATIONS COMMISSION SUPPLIER'S DECLARATION OF CONFORMITY

Product Name: DVD RDS AV RECEIVER

Model Number: AVH-3500NEX

Responsible Party Name: PIONEER ELECTRONICS (USA), INC. SERVICE SUPPORT DIVISION

Address: 2050 W. 190TH STREET, SUITE 100 TORRANCE, CA 90504, U.S.A.

Phone: 1-310-952-2915

URL: <http://www.pioneerelectronics.com>

CAN ICES-3 B/NMB-3 B**⚠ WARNING**

- This product contains chemicals known to the State of California and other governmental entities to cause cancer and birth defects or other reproductive harm. ***Wash hands after handling.***
- Slots and openings in the cabinet are provided for ventilation to ensure reliable operation of the product, and to protect it from overheating. To prevent fire hazard, the openings should never be blocked or covered with items (such as papers, floor mat, cloths).

⚠ CAUTION

This product is evaluated in moderate and tropical climate condition under the Audio, video and similar electronic apparatus - Safety requirements, IEC 60065.

The Safety of Your Ears is in Your Hands

Get the most out of your equipment by playing it at a safe level—a level that lets the sound come through clearly without annoying blaring or distortion and, most importantly, without affecting your sensitive hearing. Sound can be deceiving.

Over time, your hearing “comfort level” adapts to higher volumes of sound, so what sounds “normal” can actually be loud and harmful to your hearing. Guard against this by setting your equipment at a safe level BEFORE your hearing adapts.

► ESTABLISH A SAFE LEVEL:

- Set your volume control at a low setting.
- Slowly increase the sound until you can hear it comfortably and clearly, without distortion.
- Once you have established a comfortable sound level, set the dial and leave it there.

► BE SURE TO OBSERVE THE FOLLOWING GUIDELINES:

- Do not turn up the volume so high that you can't hear what's around you.
- Use caution or temporarily discontinue use in potentially hazardous situations.

- Do not use headphones while operating a motorized vehicle; the use of headphones may create a traffic hazard and is illegal in many areas.

Important safety information

WARNING

- Do not attempt to install or service this product by yourself. Installation or servicing of this product by persons without training and experience in electronic equipment and automotive accessories may be dangerous and could expose you to the risk of electric shock, injury or other hazards.
- Do not allow this product to come into contact with liquids. Electrical shock could result. Also, damage to the product, smoke, and overheating could result from contact with liquids.
- If liquid or foreign matter should get inside this product, park your vehicle in a safe place, turn the ignition switch off (ACC OFF) immediately and consult your dealer or the nearest authorized Pioneer Service Station. Do not use this product in this condition because doing so may result in a fire, electric shock, or other failure.
- If you notice smoke, a strange noise or odor from this product, or any other abnormal signs on the LCD screen, turn off the power immediately and consult your dealer or the nearest authorized Pioneer Service Station. Using this product in this condition may result in permanent damage to the system.
- Do not disassemble or modify this product, as there are high-voltage components inside which may cause an electric shock. Be sure to consult your dealer or the nearest authorized Pioneer Service Station for internal inspection, adjustments or repairs.

Before using this product, be sure to read and fully understand the following safety information:

- Do not operate this product, any applications, or the rear view camera option (if purchased) if doing so will divert your attention in any way from the safe operation of your vehicle. Always observe safe driving rules and follow all existing traffic regulations. If you experience difficulty in operating this product, pull over, park your vehicle in a safe location and apply the parking brake before making the necessary adjustments.
- Never set the volume of this product so high that you cannot hear outside traffic and emergency vehicles.
- To promote safety, certain functions are disabled unless the vehicle is stopped and the parking brake is applied.
- Keep this manual handy as a reference for operating procedures and safety information.
- Do not install this product where it may (i) obstruct the driver's vision, (ii) impair the performance of any of the vehicle's operating systems or safety features, including air bags or hazard lamp buttons or (iii) impair the driver's ability to safely operate the vehicle.
- Please remember to fasten your seat belt at all times while operating your vehicle. If you are ever in an accident, your injuries can be considerably more severe if your seat belt is not properly buckled.
- Never use headphones while driving.

- Rear visibility systems (backup cameras) are required in certain new vehicles sold in the U.S. and Canada. U.S. regulations began according to a two year phase-in on May 1, 2016, and both the U.S. and Canada require that all such vehicles manufactured on or after May 1, 2018 have rear visibility systems. **Owners of vehicles equipped with compliant rear visibility systems should not install or use this product in a way that alters or disables that system.** If you are unsure whether your vehicle has a rear visibility system subject to the U.S. or Canadian regulations, please contact the vehicle manufacturer or dealer.

Parking brake interlock

Certain functions (such as viewing of video image and certain touch panel key operations) offered by this product could be dangerous (possibly resulting in serious injury or death) and/or unlawful if used while driving. To prevent such functions from being used while the vehicle is in motion, there is an interlock system that senses when the parking brake is set and when the vehicle is moving. If you attempt to use the functions described above while driving, they will become disabled until you stop the vehicle in a safe place, and (1) apply the parking brake, (2) release the parking brake, and then (3) apply the parking brake again. Please keep the brake pedal pushed down before releasing the parking brake.

To ensure safe driving

WARNING

- **LIGHT GREEN LEAD AT POWER CONNECTOR IS DESIGNED TO DETECT PARKED STATUS AND MUST BE CONNECTED TO THE POWER SUPPLY SIDE OF THE PARKING BRAKE SWITCH. IMPROPER CONNECTION OR USE OF THIS LEAD MAY VIOLATE APPLICABLE LAW AND MAY RESULT IN SERIOUS INJURY OR DAMAGE.**
- **Do not take any steps to tamper with or disable the parking brake interlock system which is in place for your protection. Tampering with or disabling the parking brake interlock system could result in serious injury or death.**
- **To avoid the risk of damage and injury and the potential violation of applicable laws, this product is not for use with a video image that is visible to the driver.**
- In some countries the viewing of video image on a display inside a vehicle even by persons other than the driver may be illegal. Where such regulations apply, they must be obeyed.

If you attempt to watch video image while driving, the warning **“Viewing of front seat video source while driving is strictly prohibited.”** will appear on the screen. To watch video image on this display, stop the vehicle in a safe place and apply the parking brake. Please keep the brake pedal pushed down before releasing the parking brake.

When using a display connected to rear monitor output

The video output terminal (**rear monitor output**) is for connection of a display to enable passengers in the rear seats to watch video images.

WARNING

NEVER install the rear display in a location that enables the driver to watch video images while driving.

To avoid battery exhaustion

Be sure to run the vehicle engine while using this product. Using this product without running the engine can drain the battery.

WARNING

Do not install this product in a vehicle that does not have an ACC wire or circuitry available.

Rear view camera

With an optional rear view camera, you are able to use this product as an aid to keep an eye on trailers, or backing into a tight parking spot.

WARNING

- SCREEN IMAGE MAY APPEAR REVERSED.
- USE INPUT ONLY FOR REVERSE OR MIRROR IMAGE REAR VIEW CAMERA. OTHER USE MAY RESULT IN INJURY OR DAMAGE.

CAUTION

The rear view mode is to use this product as an aid to keep an eye on the trailers, or while backing up. Do not use this function for entertainment purposes.

Handling the USB connector

CAUTION

- To prevent data loss and damage to the storage device, never remove it from this product while data is being transferred.
- Pioneer cannot guarantee compatibility with all USB mass storage devices and assumes no responsibility for any loss of data on media players, iPhone®, smartphone, or other devices while using this product.
- It may not be recognized properly by this product if a USB device that had been incorrectly disconnected from the computer is connected.

Failure to operate

After-sales service for Pioneer products

Please contact the dealer or distributor from which you purchased the product for after-sales service (including warranty conditions) or any other information. In case the necessary information is not available, please contact the companies listed below.

Please do not ship your product to the companies at the addresses listed below for repair without making advance contact.

–USA&CANADA

Pioneer Electronics (USA) Inc.

CUSTOMER SUPPORT DIVISION

P.O. Box 1760 Long Beach, CA 90801-1760

800-421-1404

For warranty information, please see the Limited Warranty sheet included with your product.

Visit our website

Visit us at the following site:

<http://www.pioneerelectronics.com>

<http://www.pioneerelectronics.ca>

- 1 Register your product.**
- 2 Receive updates on the latest products and technologies.**
- 3 Download owner's manuals, order product catalogs, research new products, and much more.**
- 4 Receive notices of software upgrades and software updates.**

Protecting the LCD panel and screen

- Do not expose the LCD screen to direct sunlight when this product is not used. This may result in LCD screen malfunction due to the resulting high temperatures.
- When using a cellular phone, keep the antenna of the cellular phone away from the LCD screen to prevent disruption of the video in the form of spots, colored stripes, etc.
- To protect the LCD screen from damage, be sure to touch the touch panel keys only with your finger and do so gently.



Notes on internal memory

- The information will be erased by disconnecting the yellow lead from the battery (or removing the battery itself).
- Some of the settings and recorded contents will not be reset.

About this manual

This manual uses diagrams of actual screens to describe operations. However, the screens on some units may not match those shown in this manual depending on the model used.

Meanings of symbols used in this manual

	This indicates to touch the appropriate soft key on the touch screen.
	This indicates to touch and hold the appropriate soft key on the touch screen.

Protecting your unit from theft

The front panel can be detached to deter theft.

Important

- Handle the front panel with care when removing or attaching it.
- Avoid subjecting the front panel to excessive shock.
- Keep the front panel out of direct sunlight and high temperatures.
- If removed, replace the front panel on the unit before starting up your vehicle.
- To avoid damaging the device or vehicle interior, remove any cables and devices attached to the front panel before detaching it.

Removing the front panel

1 Pinch the top and bottom of its right side and pull the front panel out.

Take care not to pinch it too tightly or to drop it, and also avoid contact with water or other fluids to prevent permanent damage.

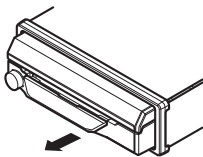

Re-attaching the front panel

1 Slide the front panel to the left.

The front panel and the head unit are connected on the left side. Make sure that the front panel has been properly connected to the head unit.

2 Press the right side of the front panel until it is firmly seated.

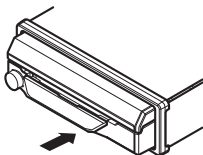

If you can't attach the front panel to the head unit successfully, try again. Forcing the front panel into place may result in damage.

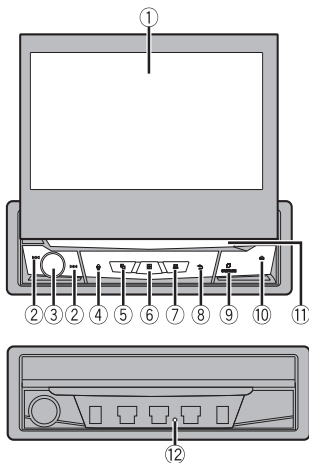

Parts and controls

Main unit



①	LCD screen	
②	◀◀ or ▶▶	Press to return to the previous track (chapter) or go to the next track (chapter). Press and hold to perform fast reverse or fast forward. Press to answer or end a call.
③	Volume/SRC/ OFF	Turn to adjust the volume. Press to cycle through all the available sources. Press and hold to turn the source off.
④		Press to activate the voice recognition mode such as Siri® when the iPhone is connected to the unit via Bluetooth or USB.
⑤		Press to switch between the Application screen and the AV operation screen. Press and hold to switch to the camera view mode. NOTE To activate the camera view mode with this button, set [Back Camera Input] to [On] (page 85).

⑥		Press to display the top menu screen. Press and hold to power off. To power back on, press any button.
⑦		Press to display the menu bar (page 21). Press and hold to mute or unmute.
⑧		Press to display the top menu screen or back to previous screen. Press and hold to turn off the display.
⑨	OPEN/CLOSE	Press to open the LCD panel. To close the LCD panel, press again.
⑩		Press to eject a disc.
⑪	Disc-loading slot	Refer to Inserting and ejecting a disc (page 39).
⑫	RESET	Press to reset the microprocessor (page 17).

Remote control

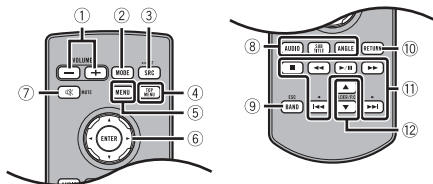

①	Volume (+/-)	
②	MODE	Press to switch between the Application screen and the AV operation screen. Press and hold to switch to the camera view mode. NOTE To activate the camera view mode with this button, set [Back Camera Input] to [On] (page 85).
③	SRC	Press to cycle through all the available sources. Press and hold to turn the source off.
④	TOP MENU	Press to return to the top menu during DVD playback.
⑤	MENU	Displays the DVD menu during DVD playback.
⑥	Thumb pad	Use to select a menu on the DVD menu.
⑦	MUTE	
⑧	AUDIO SUBTITLE ANGLE	Press to change the audio language, subtitle language or viewing angle during DVD playback.

⑨	BAND/ESC	Press to select the tuner band when tuner is selected as a source. Press to switch between media file types when playing the following types of data: • Disc • USB
⑩	RETURN	Press to return to the specified point and start playback from there.
⑪	▶/	Press to pause or resume playback or play from the beginning when resume is off.
	◀◀ or ▶▶	For audio: Press and hold to perform fast reverse or fast forward. For video: Press to perform fast reverse or fast forward.
	◀◀ or ▶▶	Press to return to the previous track (chapter) or go to the next track (chapter). Press to answer or end a call.
	■	Press to stop playback. If you resume playback, playback will start from the point where you stopped. Press the button again to stop playback completely.
⑫	FOLDER/P.CH	Press to select the next or previous title or folder. Press to recall radio station frequencies assigned to preset channel keys. Press to answer or end a call.

Basic operation

Notes on using the LCD panel

WARNING

- Keep hands and fingers clear of this product when opening, closing, or adjusting the LCD panel. Be especially cautious of children's hands and fingers.
- Do not use with the LCD panel left open. It may result in injury in the event of an accident.

CAUTION

- Do not open or close the LCD panel forcefully. It may cause a malfunction.
- Do not operate this product until the LCD panel has completely opened or closed. If this product is operated while the LCD panel is opening or closing, the LCD panel may stop at that angle for safety.
- Do not place glass or can on the open LCD panel.

Opening and closing the LCD panel

The LCD panel will open or close automatically when the ignition switch is turned on or off. You can turn off the automatic close/open function.

- Do not close the LCD panel by force with your hands. That will cause a malfunction.
- The automatic close/open function will operate the display as follows.
 - When the ignition switch is turned OFF while the LCD panel is opened, the LCD panel will close after six seconds.
 - When the ignition switch is turned ON again (or turned to ACC), the LCD panel will open automatically.
 - Removing or attaching the front panel will automatically close or open the LCD panel. Protecting your unit from theft on (page 10).
- When the ignition switch is turned OFF after the LCD panel has been closed, turning the ignition switch ON again (or turning it to ACC) will not open the LCD panel. In this case, press OPEN/CLOSE to open the LCD panel.
- When closing the LCD panel, check to make sure that it has closed completely. If the LCD panel has stopped halfway, leaving it like this could result in damage.



1 Press OPEN/CLOSE to open the LCD panel.

To close the LCD panel

Press OPEN/CLOSE again.

Setting the automatic open function

To prevent the display from hitting the shift lever of an automatic vehicle when it is in the P (park) position, or when you do not wish the display to open/close automatically, you can set the automatic open function to manual mode.

- 1 Press .
- 2 Touch  then .

The system setting screen appears.

- 3 Touch [Auto Flap].
- 4 Touch the item.
 - [On]

The LCD panel will open or close automatically when the ignition switch is turned on or off.
 - [Off]

You have to press OPEN/CLOSE to open/close the LCD panel.

Turning the LCD panel horizontally

When the LCD panel is upright and hinders the operation of the air conditioner, the panel can be turned horizontally temporarily.



- 1 Press and hold OPEN/CLOSE to display the flap menu.
- 2 Touch  to flip the LCD panel down to the horizontal position.

NOTES

- To return to the original position, press and hold OPEN/CLOSE.
- The LCD panel returns to the original position automatically, indicated with a beeping sound 10 seconds after operation.

Adjusting the LCD panel slide position

You can adjust the LCD panel slide position so that the panel is set back or forward.

- 1 Press and hold OPEN/CLOSE to display the flap menu.
- 2 Touch  (slide to the back) or  (slide to the front) to move the LCD panel.



Adjusting the LCD panel angle

Important

- If you can hear the LCD panel knocking against your vehicle's console or dashboard, touch  from the flap menu to temporarily level the LCD panel.

- When adjusting the LCD panel angle, be sure to adjust from the flap menu. Forcibly adjusting the LCD panel by hand may damage it.

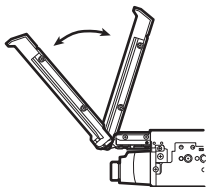

- Press and hold OPEN/CLOSE to display the flap menu.
- Touch  (tilt down) or  (tilt up) to adjust the LCD panel to an easily viewable angle.

**NOTE**

As the set angle is saved, the LCD panel will automatically be adjusted to the same position the next time the LCD panel is opened.

Resetting the microprocessor

CAUTION

- Pressing the RESET button resets settings and recorded contents to the factory settings.
 - Do not perform this operation when a device is connected to this product.
 - Some of the settings and recorded contents will not be reset.
- The microprocessor must be reset under the following conditions:
 - Prior to using this product for the first time after installation.
 - If this product fails to operate properly.
 - If there appears to be problems with the operation of the system.

- Turn the ignition switch OFF.

- 2** Press **RESET** with a pen tip or other pointed tools.
Settings and recorded contents are reset to the factory settings.

Preparing the remote control

Remove the insulation sheet before use.



How to replace the battery

CR2025 (3 V)

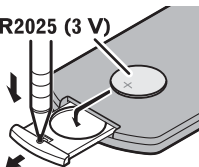

Insert the CR2025 (3 V) battery with the plus (+) and minus (-) poles orientated properly.

⚠ WARNING

- Do not ingest the battery, Chemical Burn Hazard.
(The remote control supplied with) This product contains a coin/button cell battery. If the coin/button cell battery is swallowed, it can cause severe internal burns in just 2 hours and can lead to death.
Keep new and used batteries away from children.
If the battery compartment does not close securely, stop using the product and keep it away from children.
If you think batteries might have been swallowed or placed inside any part of the body, seek immediate medical attention.
- Batteries (battery pack or batteries installed) must not be exposed to excessive heat such as sunshine, fire or the like.

⚠ CAUTION

- Remove the battery if the remote control is not used for a month or longer.
- There is a danger of explosion if the battery is incorrectly replaced. Replace only with the same or equivalent type.
- Do not handle the battery with metallic tools.
- Do not store the battery with metallic objects.
- If the battery leaks, wipe the remote control completely clean and install a new battery.
- When disposing of used batteries, please comply with governmental regulations or environmental public institution's rules that apply in your country/area.
- "Perchlorate Material – special handling may apply. See www.dtscc.ca.gov/hazardouswaste/perchlorate. (Applicable to California, U.S.A.)"

Using the remote control

Point the remote control in the direction of the front panel to operate.

NOTE

The remote control may not function properly in direct sunlight.



Important

- Do not store the remote control in high temperatures or direct sunlight.
- Do not let the remote control fall onto the floor, where it may become jammed under the brake or gas pedal.

Starting up the unit

1 Start the engine to boot up the system.

The [Select Program Language] screen appears.

NOTE

From the second time on, the screen shown will differ depending on the previous conditions.

2 Touch the language.

3 Touch .

The [Speaker Mode Settings] screen appears.

4 Touch the speaker modes.

[Standard Mode]

4-speaker system with front and rear speakers, or a 6-speaker system with front and rear speakers and subwoofers.

[Network Mode]

3-way system with a high range speaker, middle range speaker and subwoofer (low range speaker) for reproduction of high, middle and low frequencies (bands).



WARNING

Do not use the unit in Standard Mode when a speaker system for 3-way Network Mode is connected to the unit. This may cause damage to the speakers.

5 Touch [OK].

Initial Legal Disclaimer screen appears.

6 Touch [OK].

The top menu screen appears.

NOTE

Once the speaker mode is set, the setting cannot be changed unless this product is restored to the default settings. Restore the default settings to change the speaker mode setting (page 106).

Switching the speaker mode

To change the speaker mode, you need to restore this product to the default settings.

- 1 Restore the default setting (page 106).



Using the touch panel

You can operate this product by touching the keys on the screen directly with your fingers.

NOTE

To protect the LCD screen from damage, be sure to touch the screen only with your finger gently.

Common touch panel keys

- : Returns to the previous screen.
- : Close the screen.

Operating list screens

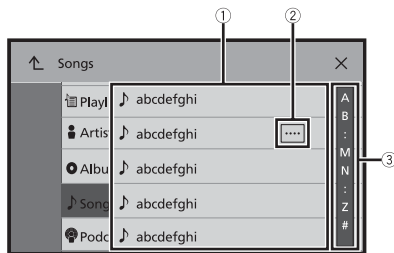

①	Touching an item on the list allows you to narrow down the options and proceed to the next operation.
②	Appears when all characters are not displayed on the display area. If you touch the key, the rests are scrolled for display. NOTE This function is available only when you stop your vehicle in a safe place and apply the parking brake.
③	Appears when items cannot be displayed on a single page. Drag the side bar, the initial search bar or the list to view any hidden items.

Operating the time bar

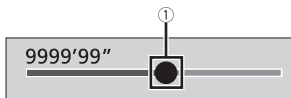

①

You can change the playback point by dragging the key.

The playback time corresponding to the position of the key is displayed while dragging the key.

Operating the menu bar







1 Press .

The menu bar pops up on the screen.

NOTE

The menu bar availability may vary depending on the activating source.







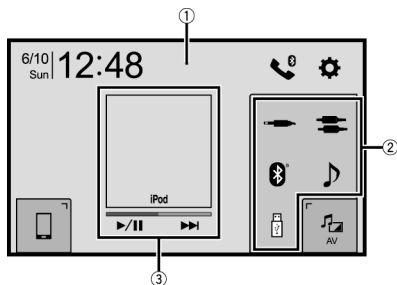

	Switches the dimmer duration by day or night.
	Switches between playback and pause.
	Skips files forward or backward. 
	
	Displays setting menu screen (page 84).
	Closes the menu bar.



Top menu screen



<p>①</p>	<p>Switches the top menu screen layout.</p> <p>1 Touch and hold .</p> <p> appears at the top of the screen.</p> <p>2 Touch .</p> <p>When you finish switching the layout, press .</p>
<p>②</p>	<p>Favorite source icons</p> <p>TIP</p> <p>If you select [Power OFF], you can turn off almost all functions.</p> <ul style="list-style-type: none"> • An incoming call is received (only for hands-free phoning via Bluetooth). • A rear view camera image is input when the vehicle is in reverse. • A button on this unit is pressed. • The ignition switch is turned off (ACC OFF), then turned on (ACC ON).
<p>③</p>	<p>AV operation area</p> <p>Displays the current source.</p> <p>Touch to go to the displayed source.</p> <p>TIPS</p> <ul style="list-style-type: none"> • When the control icons are displayed at the bottom of the key, you can control the displayed operation. • You can also switch to display/hide the artwork with the following procedure. <p>1 Touch and hold .</p> <p> or appears on the AV operation area.</p> <p>2 Touch or .</p> <p>When you finish switching the display/hide setting for the artwork, press .</p>
<p> 12:48</p>	<p>Setting the time and date (page 105)</p>





	Settings (page 84) and Favorite menu (page 104)
	<p>Connected device key Displays connected device. Switches the source or application with connected devices such as WeLink, Apple CarPlay and Android Auto.</p> <p>TIP When a device with a compatible application is connected, the favorite application key appears. Once the key appears, you can adjust the range of the favorite application key area with the following steps.</p> <ol style="list-style-type: none"> 1 Touch and hold . 2 Drag  to the desired position. When you finish adjusting, press . <p>NOTE This function is available only when you stop your vehicle in a safe place and apply the parking brake.</p>
	AV source (page 33)
	Hands-free phoning (page 26)

TIP

When you connect the external navigation system to this unit,  is displayed. Touch  to start the navigation system.

Bluetooth

Bluetooth connection

- 1 Turn on the Bluetooth function on the device.
- 2 Press .
- 3 Touch  then .
The Bluetooth screen appears.
- 4 Touch [Connection].
- 5 Touch .
- 6 Touch the Bluetooth device name.
After the device is successfully registered, a Bluetooth connection is established by the system. Once the connection is established, the device name is displayed on the list.

NOTES

- If five devices are already paired, [Memory Full] is displayed. Delete a paired device first (page 25).
- If your device supports SSP (Secure Simple Pairing), a six-digit number appears on the display of this product. Touch [Yes] to pair the device.
- If you try to connect an unconnected cellular phone while two cellular phones are already connected, the first one of the two connected cellular phones will be disconnected and the unconnected cellular phone will be connected instead.

TIPS



- The Bluetooth connection can also be made by detecting this product from the Bluetooth device. Before registration, make sure that [Visibility] in the [Bluetooth] menu is set to [On] (page 25). For details on Bluetooth device operations, refer to the operating instructions supplied with the Bluetooth device.
- Two cellular phones can be connected to this product at the same time (page 25).

Bluetooth settings

- 1 Press .
- 2 Touch  then .

CAUTION

Never turn this product off and disconnect the device while the Bluetooth setting operation is being processed.

Menu Item	Description
[Connection]	<p>Connect, disconnect, or delete registered Bluetooth device manually. Touch  to delete registered device. To connect a registered Bluetooth device manually, touch the name of the device. To disconnect the device, touch the name of the connected device in the list.</p> <p>NOTE Connect the Bluetooth device manually in the following cases:</p> <ul style="list-style-type: none"> • Two or more Bluetooth devices are registered, and you want to manually select the device to be used. • You want to reconnect a disconnected Bluetooth device. • Connection cannot be established automatically for some reason.
[Auto Connect] [On] [Off]	<p>Select [On] to connect the last connected Bluetooth device automatically.</p> <p>NOTE If two Bluetooth devices were connected the last time, the two devices are connected to this product automatically in the order that they are registered in the device list.</p>
[Visibility] [On] [Off]	<p>Select [On] to make this product visible to the other device.</p>
[PIN Code Input]	<p>Change the PIN code for Bluetooth connection. The default PIN code is "0000".</p> <ol style="list-style-type: none"> 1 Touch [0] to [9] to input the pin code (up to 8 digits). 2 Touch .
[Device Information]	<p>Displaying the device name and address of this product.</p>
[Bluetooth Memory Clear]	<p>Touch [Clear] then [OK] to clear the Bluetooth memory.</p>

Switching the connected Bluetooth device

After registering and connecting the Bluetooth devices to this product, you can switch among the devices using the switch devices key in the phone function and some audio sources.

- You can register up to five Bluetooth devices on this product (page 24).
- You can connect one of the registered devices to this product. In cases where the registered device is equipped with a phone function, a total of two devices can be connected at the same time when using the phone function. If two of the five

- registered devices are already connected, you can connect the remaining third device to use the audio function only from the switch devices key on the audio source screen.
- The icon for the cellular phone currently being used is displayed on the Phone menu screen. If you connect two cellular phones to this product at the same time, you can switch between the cellular phones using the switch devices key. The contents of the phone menu are memorized for each connected cellular phone (page 26).
 - The switch devices key will appear for some audio sources. The audio source may automatically switch to another source depending on the selected device.



Hands-free phoning

To use this function you need to connect your cellular phone to this product via Bluetooth in advance (page 24).







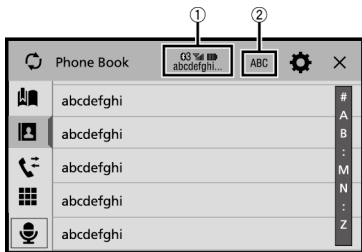

CAUTION

For your safety, avoid talking on the phone as much as possible while driving.

Making a phone call

- 1 Press .
- 2 Touch  .
The phone menu screen appears.
- 3 Touch one of the call icons on the phone menu screen.



①	<p>The following items are displayed.</p> <ul style="list-style-type: none"> • Name of the current cellular phone • List number of the current cellular phone • Reception status of the current cellular phone • Battery status of the current cellular phone <p>TIP If you connect two cellular phones to this product at the same time, you can switch between the cellular phones using the switch devices key.</p>
②	<p>Switches the search language to English or system language.</p> <p>NOTE It may not appear depending on the system language setting.</p>
	<p>Synchronizes the contacts on this product's phone book with the contacts on your phone manually.</p>
	<p>Using preset dial list (page 27)</p>
	<p>Using phone book Select a contact from the phone book. Touch the desired name on the list then select the phone number.</p> <p>TIPS</p> <ul style="list-style-type: none"> • The contacts on your phone will be automatically transferred to this product. • Update the phone book manually. <p>NOTES</p> <ul style="list-style-type: none"> • [Visibility] of the [Bluetooth] screen should be on (page 25). • If two cellular phones are automatically connected to this product with the Bluetooth device auto connect function, the phone book of the second phone is displayed.
	<p>Using call history Make a phone call from the received call , dialed call , or missed call .</p>
	<p>Direct phone number input Touch the number keys to enter the phone number then touch  to make a call.</p>

► To end the call

- 1 Touch .

Using the preset dial lists

► Registering a phone number

You can easily store up to six phone numbers per device as presets.

- 1 Press .

2 Touch .

3 Touch  or .

On the [Phone Book] screen, touch the desired name to display the contact's phone number.

4 Touch .

► Dialing from the preset dial list

1 Touch .

2 Touch the desired entry on the list to make a call.

The dial screen appears and dialing starts.

► Deleting a phone number

1 Press .

2 Touch .

3 Touch .

4 Touch .



5 Touch [Yes].

Receiving a phone call

1 Touch  to answer the call.

Touch  to end the call.

TIPS

- Touch  while getting a call waiting, switch to the talking person.
- Touch  while getting a call waiting to reject the call.

NOTE

When two phones are connected at the same time, if an incoming call is received on the second phone while you are talking on the first phone, the dial confirmation screen for the second phone will be displayed.

Voice recognition function (for iPhone)

By connecting your iPhone to this product, you can use the voice recognition function (Siri Eyes Free Mode) on this product.



NOTES

- When an iPhone is used, Siri Eyes Free Mode is available with this product.
- In this chapter, iPhone and iPod touch® will be referred to as "iPhone".

- 1 Press .
- 2 Touch .
- 3 Touch .

The voice recognition function launches and the voice control screen appears.

TIPS

- You can also launch the voice recognition function by pressing  button.
- If two cellular phones are automatically connected to this product with the Bluetooth device auto connect function, the voice recognition function (Siri Eyes Free Mode) will be set on the second phone.
- If you want to use the voice recognition function (Siri Eyes Free Mode) on another connected iPhone, touch  with numbered to the other iPhone. The iPhone that you switch to will be set as the current device.

Minimizing the dial confirmation screen

- 1 Touch .

TIP

To display the dial confirmation screen again, touch  on the top menu screen (page 22).

NOTES

- The dial confirmation screen cannot be minimized on the AV operation screen.
- AV sources cannot be selected even if the dial confirmation screen is minimized while talking on the phone or receiving an incoming call.



Phone settings

- 1 Press .
- 2 Touch  then .

Menu Item	Description
[Auto Answer] [On] [Off]	Select [On] to answer an incoming call automatically.
[Ring Tone] [On] [Off]	Select [On] if the ring tone does not come out from the car speakers.
[Invert Name]	Select [Yes] to change the order of the first and last names in the phone book.

Setting the private mode

During a conversation, you can switch to private mode (talk directly on your cellular phone).

1 Touch  or  to turn private mode on or off.

NOTES

- If two cellular phones are connected to this product and the first phone is set to private mode, you can receive incoming calls on the second phone while maintaining the call in progress on the first phone.
- When two cellular phones are connected to this product and private mode of the first phone is turned off, if an incoming call on the second phone is answered while a call is in progress on the first phone or while dialing or receiving a call on the first phone, the call, dialing, or receiving on the first phone is ended.

Adjusting the other party's listening volume

This product can be adjusted to the other party's listening volume.

1 Touch  to switch between the three volume levels.

Notes for hands-free phoning

► General notes

- Connection to all cellular phones featuring Bluetooth wireless technology is not guaranteed.
- The line-of-sight distance between this product and your cellular phone must be 10 meters or less when sending and receiving voice and data via Bluetooth technology.
- With some cellular phones, the ring sound may not be output from the speakers.
- If private mode is selected on the cellular phone, hands-free phoning may be disabled.

► Registration and connection

- Cellular phone operations vary depending on the type of cellular phone. Refer to the instruction manual that came with your cellular phone for detailed instructions.
- When phone book transfer does not work, disconnect your phone and then perform pairing again from your phone to this product.

► Making and receiving calls

- You may hear a noise in the following situations:
 - When you answer the phone using the button on the phone.
 - When the person on the other end of the line hangs up the phone.
- If the person on the other end of the line cannot hear the conversation due to an echo, decrease the volume level for hands-free phoning.
- With some cellular phones, even after you press the accept button on the cellular phone when a call comes in, hands-free phoning may not be performed.
- The registered name will appear if the phone number is already registered in the phone book. When the same phone number is registered under different names, only the phone number will be displayed.

►The received call and dialed number histories

- You cannot make a call to the entry of an unknown user (no phone number) in the received call history.
- If calls are made by operating your cellular phone, no history data will be recorded in this product.

►Phone book transfers

- If there are more than 1 000 phone book entries on your cellular phone, not all entries may download completely.
- Depending on the phone, this product may not display the phone book correctly.
- If the phone book in the phone contains image data, the phone book may not be transferred correctly.
- Depending on the cellular phone, phone book transfer may not be available.

Bluetooth audio

Before using the Bluetooth audio player, register and connect the device to this product (page 24).

NOTES

- Depending on the Bluetooth audio player connected to this product, the available operations with this product may be limited to the following two levels:
 - A2DP (Advanced Audio Distribution Profile): Only playing back songs on your audio player is possible.
 - A2DP and AVRCP (Audio/Video Remote Control Profile): Playing back, pausing, selecting songs, etc., are possible.
- Depending on the Bluetooth device connected to this product, the available operations with this product may be limited or differ from the descriptions in this manual.
- While you are listening to songs on your Bluetooth device, refrain from operating the phone function as much as possible. If you try operating, the signal may cause noise for song playback.
- When you are talking on the Bluetooth device connected to this product via Bluetooth, it may pause playback.

1 Press .

2 Touch  then .

The system setting screen appears.

3 Touch [AV Source Settings].

4 Confirm that [Bluetooth Audio] is turned on.

5 Press .

6 Touch .

The AV source screen appears.

7 Touch [Bluetooth Audio].

The Bluetooth audio playback screen appears.

Basic operation

Bluetooth audio playback screen



①	Track number indicator
	Switches between playback and pause.
	Skips files forward or backward. <ul style="list-style-type: none">• By pressing then touch or , you can also skip files forward or backward.• By pressing then touch and hold or , you can also perform fast reverse or fast forward.
	Sets a repeat play range.
	Plays files in random order.
	Selects a file or folder from the list to playback. <p>NOTE This function is available only when the AVRCP version of the Bluetooth device is 1.4 or higher.</p>
	Switches among the Bluetooth devices when the devices are connected to this product via Bluetooth (page 25).

AV source

Supported AV source

You can play or use the following sources with this product.

- Radio
- CD
- Disc (compressed audio or video files on discs)
- DVD-Video
- USB

The following sources can be played back or used by connecting an auxiliary device.

- iPod
- Spotify®
- Pandora®
- Bluetooth® audio
- SiriusXM® Satellite Radio
- AV input (AV)
- AUX

Displaying the AV operation screen

- 1 Press  then touch the AV operation key.

The AV operation screen appears.



①



Displays the source list.





Selects or customizes the equalizer curve (page 94).

Selecting a source

Source on the AV source selection screen

- 1 Press  then touch .
- 2 Touch the source icon.
When you select [Source OFF], the AV source is turned off.

Source on the source list



- 1 Press  then touch the AV operation key.
- 2 Touch .
- 3 Touch the source key.
When you select [Source OFF], the AV source is turned off.

Changing the display order of source



NOTE

This function is available only when you stop your vehicle in a safe place and apply the parking brake.

Changing the display order of source icons

- 1 Press  then touch .
- 2 Touch and hold the source icon and drag the icon to the desired position.





Changing the display order of source keys

- 1 Press  then touch the AV operation key.
- 2 Touch .
- 3 Touch .
- 4 Drag the source key to the desired position.

Adjusting the range of favorite source icons area



NOTE

This function is available only when you stop your vehicle in a safe place and apply the parking brake.

- 1 Press .
- 2 Touch and hold .
 appears at the top left of the favorite source icons.
- 3 Drag  to the desired position.
When you finish adjusting, press .

Radio







Starting procedure



- 1 Press  then touch .
- 2 Touch [Radio].
The Radio screen appears.

Basic operation

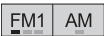





Radio screen



	 Recalls the preset channel stored to a key from memory.
	 Stores the current broadcast frequency to a key.
	Displays the preset channel list. Select an item on the list ([1] to [6]) to switch to the preset channel.
	Selects the FM1, FM2, FM3, or AM band.
	Performs BSM (best stations memory) function (page 37).

 		Manual tuning
		Seek tuning or non stop seek tuning
		Releasing the key in a few seconds skips to the nearest station from the current frequency. Keep holding the key for long seconds to perform non stop seek tuning.

TIPS

- By pressing  then touch  or , you can also switch the preset channels.
- By pressing  then touch and hold  or  and releasing it, you can also perform seek tuning.

Storing the strongest broadcast frequencies (BSM)

The BSM (best stations memory) function automatically stores the six strongest broadcast frequencies under the preset channel keys [1] to [6].

NOTES

- Storing broadcast frequencies with BSM may replace those you have already saved.
- Previously stored broadcast frequencies may remain stored if the number of frequencies stored has not reached the limit.

1 Touch  to begin search.

While the message is displayed, the six strongest broadcast frequencies will be stored under the preset channel keys in the order of their signal strength.

To cancel the storage process

1 Touch [Cancel].

Radio settings

1 Press .

2 Touch  then .

The system setting screen appears.

3 Touch [AV Source Settings].

4 Touch [Radio settings].

The menu items vary according to the source.

Menu Item	Description
[Local] [Off] FM: [Level1] [Level2] [Level3] [Level4] AM: [Level1] [Level2]	Local seek tuning allows you to only tune into radio stations with sufficiently strong signals. NOTES <ul style="list-style-type: none">• [Level4] for FM and [Level2] for AM are available only with the stations with the strongest signals.• This setting is available only when [Radio] is selected as the source.

Disc

Inserting and ejecting a disc

You can play a normal music CD, Video-CD, or DVD-Video using the built-in drive of this product.

CAUTION

Do not insert anything other than a disc into the disc-loading slot.

Inserting a disc

1 Insert a disc into the disc-loading slot.

The source changes and then playback will start.

NOTE







If the disc is already set, select [Disc] as the playing source.

Ejecting a disc

1 Press .





Basic operation

TIPS

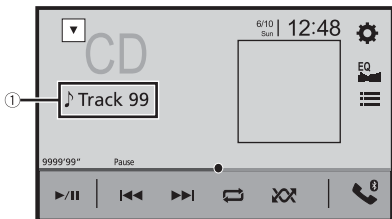
- By pressing  then touch  or , you can also skip files/chapters forward or backward.
- By pressing  then touch and hold  or , you can also perform fast reverse or fast forward.
- If a Video-CD with PBC (playback control) On is being played,  appears.
- You can set the screen size for the video image (page 105).

Audio source screen











①	Track number indicator
	Switches between playback and pause.
	Skips files forward or backward.
	Sets a repeat play for the current disc/the current track.
	Plays or does not play tracks in random order.
	Selects a track from the list. Touch a track on the list to play back.

CAUTION

For safety reasons, video images cannot be viewed while your vehicle is in motion. To view video images, stop in a safe place and apply the parking brake.

Video source screen 1

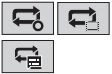

①	<p>Hides the touch panel keys. To display the keys again, touch anywhere on the screen.</p>
	<p>Performs fast reverse or fast forward. Touch again to change the playback speed.</p>
	<p>Stops playback.</p>
	<p>Performs frame-by-frame playback. </p> <p>Performs slow-motion playback. Each time you touch , it changes the speed in four steps in the following order: 1/16 -> 1/8 -> 1/4 -> 1/2</p>
	<p>Displays the DVD menu.</p> <p>NOTE This function may not work properly with some DVD disc content. In that case, use touch panel keys to operate the DVD menu.</p>
	<p>Sets a repeat play for all files/the current chapter/the current title.</p>
	<p>Switches the audio/subtitle language.</p>
	<p>Displays the hidden function bar.</p> <p>TIP You can also display the hidden function bar by flicking the bar from the right to the left.</p>

	<p>Searches for the part you want to play. Touch [Title], [Chapter], [10Key], or [Track] then input the desired number from [0] to [9]. To start playback from the number you registered, touch .</p> <p>TIPS</p> <ul style="list-style-type: none"> • To cancel an input number, touch [C]. • For DVD-Videos, you can select [Title], [Chapter] or [10Key]. • For Video-CDs, you can select [Track] or [10key].*
	<p>Skips files/chapters forward or backward.</p>

* PBC (playback control) only

Video source screen 2

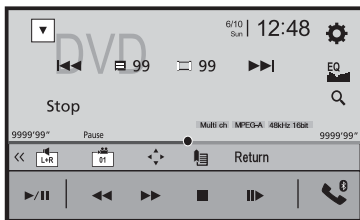

	<p>Displays the hidden function bar.</p> <p>TIP You can also display the hidden function bar by flicking the bar from the left to the right.</p>
	<p>Selects the audio output from [L+R], [Left], [Right], [Mix]. This function is available for Video-CDs and DVDs recorded with LPCM audio.</p>
	<p>Changes the viewing angle (Multi-angle). This function is available for DVDs featuring multi-angle recordings.</p>
	<p>Displays the DVD menu keypad. If items on the DVD menu appear, the touch panel keys may overlay them. If so, select an item using these touch panel keys. Touch , , , or to select the menu item then touch .</p> <p>NOTE The way to display the menu differs depending on the disc.</p> <p>TIP If you touch , you can operate the DVD menu directly.</p>

	<p>Resumes playback (Bookmark). This function is available for DVD-Video. You can memorize one point as a Bookmark for a disc (up to five discs). To clear the bookmark on the disc, touch and hold this key.</p>
Return	<p>Returns and begins playback from the specified point. This function is available for DVD-Video and Video-CDs featuring PBC (playback control).</p>

Compressed files

Inserting and ejecting media

You can play compressed audio, compressed video, or still image files stored in a disc or an external storage device.

CAUTION

Do not insert anything other than a disc into the disc-loading slot.

Inserting a disc

1 Insert a disc into the disc-loading slot.

The source changes and then playback will start.

NOTE

If the disc is already set, select [Disc] as the playing source.

Ejecting a disc

1 Press .

Plugging a USB storage device

1 Pull out the plug from the USB port of the USB cable.

2 Plug a USB storage device into the USB cable.

NOTES

- This product may not achieve optimum performance with some USB storage devices.
- Connection via a USB hub is not possible.
- A USB cable is required for connection.

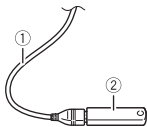

①

USB cable

Unplugging a USB storage device

- 1 Pull out the USB storage device from the USB cable.

NOTES

- Check that no data is being accessed before pulling out the USB storage device.
- Turn off (ACC OFF) the ignition switch before unplugging the USB storage device.

Starting procedure



For Disc

- 1 Insert the disc (page 44).

TIP

If the disc is already set, select [Disc] as the playing source.

For USB

- 1 Press  then touch .







- 2 Plug the USB storage device into the USB cable (page 44).

- 3 Touch [USB].

Playback is performed in order of folder numbers. Folders are skipped if they contain no playable files.





Basic operation

TIPS

- By pressing  then touch  or , you can also skip files/chapters forward or backward.
- By pressing  then touch and hold  or  on the audio or video file, you can also perform fast reverse or fast forward.
- You can set the screen size for the video and image files (page 105).

Audio source screen 1 (Example: USB)



<p>①</p>	<p>Displays the link search screen. Touch the song to play back followed by the song information, after switching to Music Browse mode (page 47).</p> <p>TIP If you touch the artwork, the list of songs in the album is displayed.</p> <p>NOTE This function is available for the USB storage device only.</p>
	<p>Switches between playback and pause.</p>
	<p>Skips files forward or backward.</p>
	<p>Sets a repeat play range for all files/the current folder/the current file.</p>
	<p>Plays files or does not play in random order.</p>
	<p>Displays the hidden function bar.</p> <p>TIP You can also display the hidden function bar by flicking the bar from the right to the left.</p>

	<p>Switches the following media file types.</p> <p>[Music]: Compressed audio files [Video]: Compressed video files [CD-DA]: Audio data (CD-DA) [Photo]: Image files</p>
	<p>Selects a file from the list. Touch a file on the list to playback.</p> <p>TIP Touching a folder on the list shows its contents. You can play a file on the list by touching it.</p> <p>NOTE When you play compressed audio files stored in a USB storage device, you can search for a file using Music Browse (page 47).</p>

Audio source screen 2 (Example: USB)

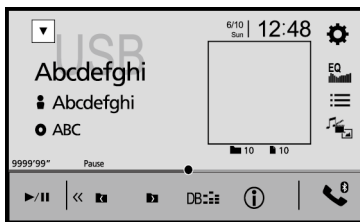

	<p>Displays the hidden function bar.</p> <p>TIP You can also display the hidden function bar by flicking the bar from the left to the right.</p>
	<p>Selects the previous folder or the next folder.</p>
	<p>Constructs the database for using the Music Browse mode (page 47).</p>
	<p>Switches the current music information display.</p>

▶ Selecting a file using Music Browse mode

You can select files to play back using the category list if the files contain tag information.

NOTES

- This function is available for the USB storage device only.
- Music Browse mode cannot be held once the power is turned off.

1 Touch  to create a database.

Music Browse mode will be available after the database has been created.

2 Touch .**3 Touch the desired category to display the file list.****4 Touch the item.**

Refine the item until the desired song title or file name is displayed on the list.

5 Touch the desired song title or file name to play back.

If the selection made with Music Browse has been canceled, you can switch to Music Browse mode again by touching the [Tag] tab on the file/folder list screen and touching the desired track.

TIP

Once the database is created in the USB storage, there is no need to create the database again as long as the same contents are saved. To enter the Music Browse mode directly, touch  and then touch [Tag] before selecting the song.

Video source**⚠ CAUTION**

For safety reasons, video images cannot be viewed while your vehicle is in motion. To view video images, stop in a safe place and apply the parking brake.









Video source screen (Example: USB)

①

Hides the touch panel keys.

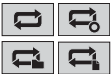

To display the keys again, touch anywhere on the screen.

**Switches between playback and pause.**

	Performs fast reverse or fast forward. Touch again to change the playback speed.
	Stops playback.
	 Performs frame-by-frame playback.
	 Performs slow-motion playback.
	Sets a repeat play range for all files/the current folder/the current file.
	Switches the audio/subtitle language. NOTE Switching of the subtitle function is only available on disc.
	Switches the following media file types. [Music]: Compressed audio files [Video]: Compressed video files [CD-DA]: Audio data (CD-DA) [Photo]: Image files
	Selects a file from the list. Touch a file on the list to playback. TIP Touching a folder on the list shows its contents. You can play a file on the list by touching it.
	Skips files forward or backward.







Still image source

TIPS

- Image files are not displayed in the rear display.
- By pressing  then touch and hold  or  on the still image file, you can search through 10 image files at a time. If the file currently being played is the first or last file in the folder, the search is not performed.

Still image screen



①	<p>Hides the touch panel keys. To display the keys again, touch anywhere on the screen.</p>
▶/	<p>Switches between playback and pause.</p>
◀◀ ▶▶	<p>Skips files forward or backward.</p>
◀ ▶	<p>Selects the previous folder or the next folder.</p>
	<p>Saves the current images as the wallpaper. Touch the following items then touch [Yes] to overwrite the image. [As AVScreen]: Saves the image as the wallpaper for the AV screen. [As HomeScreen]: Saves the image as the wallpaper for the top menu screen. [As Both]: Saves the image as the wallpaper for both the AV screen and top menu screen.</p> <p>NOTE If you save the new image, the current wallpaper is overwritten except for the preset image.</p>
	<p>Rotates the displayed picture 90° clockwise.</p>
 	<p>Sets a repeat play range for all files/the current folder.</p>
 	<p>Plays all files in the current repeat play range or does not play them in random order.</p>
	<p>Switches the following media file types. [Music]: Compressed audio files [Video]: Compressed video files [CD-DA]: Audio data (CD-DA) [Photo]: Image files</p>



Selects a file from the list.

Touch a file on the list to playback.

TIP

Touching a folder on the list shows its contents. You can play a file on the list by touching it.

iPod®

Connecting your iPod

When connecting an iPod to this product, the settings are automatically configured according to the device to be connected. For details of the compatibility, refer to Compatible iPod/iPhone models (page 123).

NOTES

- Depending on the generation or version of the iPod, some functions may not be available.
- Do not delete the Apple Music® app from your iPod, since some functions may not be available.

1 Connect your iPod.

- iPhone or iPod via USB or Bluetooth

2 Press then touch .







3 Touch [iPod].

NOTES

- For USB connection, refer to the Installation Manual.
- For Bluetooth connection, see page 24.

Basic operation







TIPS

- By pressing  then touch  or , you can also skip files forward or backward.
- By pressing  then touch and hold  or , you can also perform fast reverse or fast forward.

Audio source

Audio source screen 1



<p>①</p>	<p>Displays the link search screen. Select a song from the list related to the song currently playing.</p> <p>TIP If you touch the artwork, the list of songs in the album is displayed.</p> <p>NOTE This function is not available while playing Apple Music Radio.</p>
	<p>Switches between playback and pause.</p>
	<p>Skips files forward or backward.</p>
	<p>Sets a repeat play range for all in the selected list/the current song.</p>
	<p>Plays songs within the selected list/album randomly.</p>
	<p>Displays the hidden function bar.</p> <p>NOTE Only available when audiobook is played.</p>
	<p>Switches among connected devices.</p>
	<p>Selects a song from the list. Touch the category then the title of the list to playback of the selected list.</p> <p>TIPS</p> <ul style="list-style-type: none"> • If you use English as the system language, the alphabet search function is available. Touch the initial search bar to use this function. • When you touch Apple Music Radio station in the list screen, Apple Music Radio screen appears (page 54). <p>NOTES</p> <ul style="list-style-type: none"> • Depending on the generation or version of the iPod, some functions may not be available. • Only 16 000 songs in the iPod are available in the list if the iPod has more than 16 000 songs. Available songs depend on the iPod.

Audio source screen 2

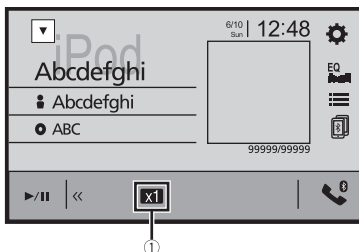

①	Changes the audiobook speed. Normal—Fast—Slow
⏪	Displays the hidden function bar.

Apple Music® Radio source

Important

Apple Music Radio may not be available in your country or region. For details about Apple Music Radio, visit the following site: <http://www.apple.com/music/>



NOTE

This function is only available when using the iPod function with iOS 8 or higher (up to iOS 11) installed on iPhone 7, iPhone 7 Plus, iPhone SE, iPhone 6s, iPhone 6s Plus, iPhone 6, iPhone 6 Plus, iPhone 5s, iPhone 5c, iPhone 5 or iPod touch (5th and 6th generation).

Apple Music Radio screen



▶/⏸	Switches between playback and pause.
-----	---

	<p>Displays the pop-up menu for Apple Music Radio.</p> <ul style="list-style-type: none">• Touch [Play More Like This] to play back songs similar to the current song.• Touch [Play Less Like This] to set it not to play back the current song again.• Touch [Add to iTunes Wish List] to add the current song to the iTunes® wish list. <p>NOTE This function may not be used depending on your Apple Music account status.</p>
	<p>Skips tracks forward.</p>

WebLink™

WebLink lets you enjoy compatible smartphones apps in the car. You can operate WebLink compatible applications with finger gestures such as tapping, dragging, scrolling, or flicking on the screen of this product.

NOTES

- The supported finger gestures may vary depending on the WebLink compatible application.
- To use WebLink, you must first install the WebLink Host app on the iPhone or smartphone. For details about the WebLink Host app, visit the following site: <https://www.abaltatech.com/weblink/>
- Be sure to read Using app-based connected content (page 123) before you perform this operation.
- Copyright protected files such as DRM cannot be played.

⚠ WARNING

Certain uses of the iPhone or smartphone may not be legal while driving in your jurisdiction, so you must be aware of and obey any such restrictions. If in doubt as to a particular function, only perform it while the car is parked. No feature should be used unless it is safe to do so under the driving conditions you are experiencing.

Using WebLink

🔔 Important

- Pioneer is not liable for any issues that may arise from incorrect or flawed app-based content.
- The content and functionality of the supported applications are the responsibility of the App providers.
- In WebLink, functionality through the product is limited while driving, with available functions determined by the App providers.
- Availability of WebLink functionality is determined by the App provider, and not determined by Pioneer.
- WebLink allows access to applications other than those listed that are subject to limitations while driving.

Starting procedure

When connecting an iPhone or a smartphone to this product, the settings are automatically configured according to the device to be connected.

TIPS

- Touch the desired application icon after the WebLink app is launched.
- If you connect your device to this product while a WebLink compatible application is already running, the application operation screen will appear on this product.
- The desired application is launched, and the application operation screen appears.
- Press **⏪** to go back to the top menu screen.

WebLink

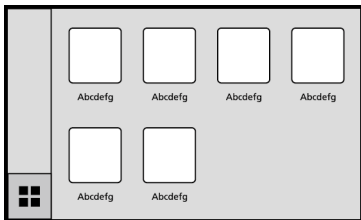

Displays the main menu of the WebLink source screen.

TIP

When the rear display is connected to this unit, video from the WebLink screen can be displayed to the rear display except while the AV source with video content is active even while driving.

For iPhone users

System requirement

iOS 10.0 or higher (up to iOS 11.x)

NOTE

iPhone 4s is not available on the WebLink.

1 Unlock your iPhone and connect it to this product via USB.

Refer to the Installation Manual.

2 Press .

3 Touch .

4 Touch [WebLink].

5 Touch desired icon in the tab.

The WebLink app is launched.



For smartphone (Android™) users

System requirement

Android 5.0 or higher (up to Android 8.x)

NOTES

- [USB MTP] is set to [Off] to use WebLink (page 85).

- The video playback capability depends on the connected Android device.
- 1 Unlock your smartphone and connect it to this product via USB.**
Refer to the Installation Manual.
 - 2 Press** .
 - 3 Touch** .
 - 4 Touch [WebLink].**
 - 5 Touch desired icon in the tab.**
The WebLink app is launched.

Using the audio mix function

You can output the audio mixing AV source and an application for iPhone or smartphone when WebLink is used.

NOTE

Depending on the application or AV source, this function may not be available.

- 1 Start up the WebLink.**
- 2 Press VOL (+/-).**
The audio mix menu will be displayed on the screen.

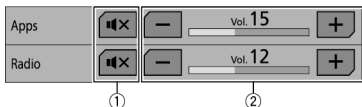

①	Touch to mute. Touch again to cancel mute.
②	Adjusts the audio volume.

Apple CarPlay™

You can operate iPhone applications with finger gestures such as tapping, dragging, scrolling, or flicking on the screen of this product.

Compatible iPhone models

For details about compatibility of iPhone models, refer to the following website.
<http://www.apple.com/ios/carplay>

NOTE

The compatible finger gestures vary depending on the application for the iPhone.

⚠ WARNING

Certain uses of the iPhone may not be legal while driving in your jurisdiction, so you must be aware of and obey any such restrictions. If in doubt as to a particular function, only perform it while the car is parked. No feature should be used unless it is safe to do so under the driving conditions you are experiencing.

Using Apple CarPlay

🔄 Important

Apple CarPlay may not be available in your country or region.

For details about Apple CarPlay, visit the following site:

<http://www.apple.com/ios/carplay>

- The content and functionality of the supported applications are the responsibility of the App providers.
- In Apple CarPlay, usage is limited while driving, with availability of functions and content determined by the App providers.
- Apple CarPlay allows access to applications other than those listed that are subject to limitations while driving.
- PIONEER IS NOT RESPONSIBLE AND DISCLAIMS LIABILITY FOR THIRD PARTY (NON-PIONEER) APPS AND CONTENT, INCLUDING WITHOUT LIMITATION ANY INACCURACIES OR INCOMPLETE INFORMATION.

Setting the driving position

To achieve optimum usability of Apple CarPlay, set the driving position setting correctly according to the vehicle. The setting will be applied the next time an Apple CarPlay compatible device is connected to this product.



1 Press .

2 Touch  then .

The system setting screen appears.

- 3 Touch [Driving Position].
- 4 Touch the item.
[Left]
Select for a left-hand drive vehicle.
[Right]
Select for a right-hand drive vehicle.

Starting procedure

- 1 Connect an Apple CarPlay compatible device to this product via USB.
- 2 Press .
- 3 Touch .
- 4 Touch [Apple CarPlay].
- 5 Touch Apple CarPlay icon in the tab.
The application screen appears.

TIP

You can use Siri function by pressing  button once Apple CarPlay is activated.

NOTES

- For details on USB connection, refer to the Installation Manual.
- If an Apple CarPlay compatible device has been connected and another screen is displayed, touch [Apple CarPlay] on the top menu screen to display the Application menu screen.
- The Bluetooth connection with the Apple CarPlay compatible device will be terminated automatically if Apple CarPlay is turned on. While Apple CarPlay is turned on, only a Bluetooth audio connection will be possible for devices other than the device connected via Apple CarPlay.
- Hands-free phoning via Bluetooth wireless technology is not available while Apple CarPlay is on. If Apple CarPlay is turned on during a call on a cellular phone other than an Apple CarPlay compatible device, the Bluetooth connection will be terminated after the call ends.

Adjusting the volume

You can adjust the guidance volume separately from the main sound volume when Apple CarPlay is used.

- 1 While Apple CarPlay is activated, press VOL (+/-).
The volume menu will be displayed on the screen.

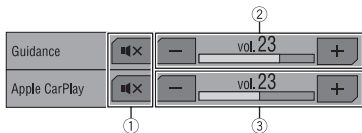

①	Touch to mute. Touch again to cancel mute.
②	Touch [+] / [-] to adjust the guidance volume.
③	Displays the main sound volume. To adjust the main sound volume, press VOL (+/-) on the unit or touch [+] / [-].

NOTE

The volume menu is displayed for four seconds. If the menu disappears, press **VOL (+/-)** again. The menu reappears.

Android Auto™

You can operate Android applications with finger gestures such as tapping, dragging, scrolling, or flicking on the screen of this product.

Compatible Android devices

For details about compatibility of Android models, refer to the following website.
<https://support.google.com/androidauto>

NOTES

- [USB MTP] is set to [Off] to use Android Auto (page 85).
- The compatible finger gestures vary depending on the application for the smartphone.

WARNING

Certain uses of the smartphone may not be legal while driving in your jurisdiction, so you must be aware of and obey any such restrictions. If in doubt as to a particular function, only perform it while the car is parked. No feature should be used unless it is safe to do so under the driving conditions you are experiencing.

Using Android Auto

Important

Android Auto may not be available in your country or region.

For details about Android Auto, please refer to the Google™ support site:

<http://support.google.com/androidauto>

- The content and functionality of the supported applications are the responsibility of the App providers.
- In Android Auto, usage is limited while driving, with availability of functions and content determined by the App providers.
- Android Auto allows access to applications other than those listed that are subject to limitations while driving.
- PIONEER IS NOT RESPONSIBLE AND DISCLAIMS LIABILITY FOR THIRD PARTY (NON-PIONEER) APPS AND CONTENT, INCLUDING WITHOUT LIMITATION ANY INACCURACIES OR INCOMPLETE INFORMATION.

Setting the driving position

To achieve optimum usability of Android Auto, set the driving position setting correctly according to the vehicle. The setting will be applied the next time an Android Auto compatible device is connected to this product.



1 Press .

2 Touch  then .

The system setting screen appears.

- 3 Touch [Driving Position].
- 4 Touch the item.
[Left]
Select for a left-hand drive vehicle.
[Right]
Select for a right-hand drive vehicle.

Starting procedure

- 1 Connect an Android Auto™ compatible device to this product via USB.
- 2 Press .
- 3 Touch .
- 4 Touch [Android Auto].
- 5 Touch Android Auto icon in the tab.
The application screen appears.

TIP

You can use voice recognition function by pressing  button once Android Auto is activated.

NOTES

- For details on USB connection, refer to the Installation Manual.
- When the device for Android Auto is connected to this unit, the device is also connected via Bluetooth at the same time. If five devices are already paired, the message confirming whether to delete the registered device is displayed. If you want to delete the device, touch [Agree]. If you want to delete other device, touch [BT Settings] and delete the devices manually (page 25).
- If Android Auto is turned on during a call on a cellular phone other than the Android Auto compatible device, the Bluetooth connection will switch to the Android Auto compatible device after the call.

Adjusting the volume

You can adjust the guidance volume separately from the main sound volume when Android Auto is used.

- 1 While Android Auto is activated, press VOL (+/-).
The volume menu will be displayed on the screen.

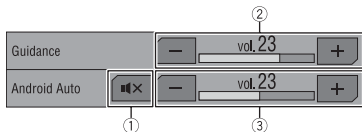

①	Touch to mute. Touch again to cancel mute.
②	Touch [+] / [-] to adjust the guidance volume.
③	Displays the main sound volume. To adjust the main sound volume, press VOL (+/-) on the unit or touch [+] / [-].

NOTE

The volume menu is displayed for four seconds. If the menu disappears, press **VOL (+/-)** again. The menu reappears.

Setting the auto-launch function

If this function is set to on, Android Auto will launch automatically when an Android Auto compatible device is connected to this product.

NOTE

Android Auto will launch automatically only when an Android Auto compatible device is correctly connected to this product.

- 1 Press .
- 2 Touch  then .
- 3 Touch [Android Auto Auto-launch] to switch [On] or [Off].

Pandora®

Pandora Music is a music service not affiliated with Pioneer. More information is available at <http://www.pandora.com>.

The Pandora mobile application is available for iPhone and smartphones. Please visit www.pandora.com/everwhere/mobile for the latest compatibility information.

WARNING

Certain uses of the iPhone or smartphone may not be legal while driving in your jurisdiction, so you must be aware of and obey any such restrictions.

If in doubt as to a particular function, only perform it while the car is parked.

No feature should be used unless it is safe to do so under the driving conditions you are experiencing.

Important

- Create a free or a paid account online. You can create the account in the Pandora application from your iPhone or smartphone, or from the website (<http://www.pandora.com/account/register>).
- To use the Pandora service, you need to connect to the Internet via 3G, EDGE, LTE (4G), or Wi-Fi network. If the data plan for your iPhone or smartphone does not provide for unlimited data usage, additional charges from your carrier may apply.

Limitations:

- Depending on the availability of the Internet, you may not be able to receive the Pandora service.
- The Pandora service is subject to change without notice. The service could be affected by any of the following: firmware version of the iPhone or smartphone, firmware version of the Pandora application, changes to the Pandora music service.
- Certain functions of the Pandora service are not available when accessing the service through Pioneer car audio/video products. They include, but are not limited to the following: sending information about current stations, buying tracks from iTunes App Store® or Google Play, viewing additional text information, logging in to Pandora, adjusting Cell Network Audio Quality.

NOTE

In this chapter, iPhone and iPod touch will be referred to as "iPhone".

Listening to Pandora

Update the firmware of the Pandora application to the latest version before use.

1 Unlock the mobile device and connect it to this product.

- iPhone via USB or Bluetooth
- Smartphone via Bluetooth

2 Press then touch .

- 3 Touch [Pandora].
- 4 Launch the Pandora application on the mobile device and start playback.



NOTES

- For details on Bluetooth connection, see page 24.
- For details on USB connection, refer to the Installation Manual.

Basic operation

Playback screen



	<p>Recalls the preset station stored to a key from the memory.</p>
	<p>Stores the current station to a key.</p>
	<p>Displays the preset station list. Select an item on the list ([1] to [6]) to switch to the preset station.</p>
	<p>Switches between playback and pause.</p>
	<p>Skips tracks forward.</p> <p>TIP By touching (pressing)  then touch , you can skip songs forward.</p> <p>NOTE The number of tracks that are skipped varies depending on the application.</p>
	<p>Gives a Thumbs Up to the playing track.</p>
	<p>Gives a Thumbs Down to the playing track and skips to the next track.</p> <p>NOTE The number of tracks that are skipped varies depending on the application.</p>

	<p>Creates a new station. Touch [Track] or [Artist] to create a new station.</p>
	<p>Adds information for the track currently playing to bookmarks.</p>
	<p>Switches among connected devices.</p>
	<p>Selects a Pandora station from the list.</p> <ul style="list-style-type: none"> • : Switches to the station list. • : Switches to the genre list. • : Plays only one track based on particular musical characteristics from several shuffled stations. • : Deletes the station. • A-Z: Sorts the items in the list alphabetically. • Date: Sorts the items in the list in the order of the dates. <p>TIP Shared stations are indicated by .</p>

* and are not available when using a shared station.

Spotify®

To enjoy Spotify as you drive, first download the Spotify app to your iPhone or smartphone. You can download it from the iTunes App Store or Google Play. Choose a free account or a paid Premium account, either in the app or at spotify.com. A Premium account gives you more features like offline listening. If you have Spotify already, please update the app so you have the latest version then connect your phone to your car. Now you can take your music on the road.

WARNING

Certain uses of the iPhone or smartphone may not be legal while driving in your jurisdiction, so you must be aware of and obey any such restrictions. If in doubt as to a particular function, only perform it while the car is parked. No feature should be used unless it is safe to do so under the driving conditions you are experiencing.

Important

- To use Spotify, you need to connect to the Internet via 3G, EDGE, LTE (4G), or a Wi-Fi network. If the data plan for your iPhone or smartphone does not provide for unlimited data usage, additional charges from your carrier may apply.
- For information on the countries and regions where Spotify can be used, take a look at <https://www.spotify.com/us/select-your-country/>.

Limitations:

- Depending on the availability of the Internet, you may not be able to receive the Spotify service.
- The Spotify service is subject to change without notice. The service could be affected by any of the following: firmware version of the iPhone or smartphone, firmware version of the Spotify application, changes to the Spotify music service.
- Certain functions of the Spotify service are not available when accessing the service through Pioneer car audio/video products.
- Spotify is a music service not affiliated with Pioneer. More information is available at <https://support.spotify.com/>.
- The Spotify application is available for most iPhone and smartphone, please visit <https://support.spotify.com/> for the latest compatibility information.





Listening to Spotify

Update the firmware of the Spotify application to the latest version before use.

1 Unlock the mobile device and connect it to this product.

- iPhone via USB or Bluetooth
- Smartphone via Bluetooth

2 Press .

- 3 Touch  then .
- 4 Touch [AV Source Settings].
- 5 Confirm that [Spotify] is turned on.
- 6 Press  then touch .
- 7 Touch [Spotify].







NOTES



- For details on Bluetooth connection, see page 24.
- For details on USB connection for iPhone, refer to the Installation Manual.

Basic operation

Playback screen 1 (Track)





	Switches between playback and pause.
	Skips tracks forward or backward. TIP By pressing  then touch  , you can skip tracks forward. NOTE The number of tracks that are skipped varies depending on the application.
	Switches to radio mode.
	Saves or deletes the current song information to or from Your Music.

	<p>Displays the hidden function bar.</p> <p>TIP You can also display the hidden function bar by flicking the bar from the right to the left.</p>
	<p>Switches among connected devices.</p>
	<p>Selects a track or station from the list.</p> <p>Your Music: Selects a track or station from the list of saved song information. Browse: Selects a track from the category list. Radio: Selects a station from the station list. Recently Played: Selects a track from recently played.</p>









Playback screen 2 (Track)



	<p>Displays the hidden function bar.</p> <p>TIP You can also display the hidden function bar by flicking the bar from the left to the right.</p>
	<p>Sets a repeat play range.</p>
	<p>Plays tracks in random order.</p>



Playback screen 1 (Radio mode)



	<p>Switches between playback and pause.</p>
	<p>Skips tracks forward or backward.</p> <p>TIP By pressing  then touch , you can skip songs forward.</p> <p>NOTE The number of tracks that are skipped varies depending on the application.</p>
	<p>Starts new radio mode.</p>
	<p>Saves or deletes the current song information to or from Your Music.</p>
	<p>Displays the hidden function bar.</p> <p>TIP You can also display the hidden function bar by flicking the bar from the right to the left.</p>
	<p>Switches among connected devices.</p>
	<p>Selects a track or station from the list. Your Music: Selects a track or station from the list of saved song information. Browse: Selects a track from the category list. Radio: Selects a station from the station list. Recently Played: Selects a track from recently played.</p>

Playback screen 2 (Radio mode)



	<p>Displays the hidden function bar.</p> <p>TIP You can also display the hidden function bar by flicking the bar from the left to the right.</p>
	<p>Gives a Thumbs Up to the playing track.</p>
	<p>Gives a Thumbs Down to the playing track and skips to the next track.</p> <p>NOTE The number of tracks that are skipped varies depending on the application.</p>

SiriusXM® Satellite Radio

Only SiriusXM® brings you more of what you love to listen to, all in one place. Get over 140 channels, including commercial-free music plus the best sports, news, talk, comedy, and entertainment. Welcome to the world of satellite radio. A SiriusXM Connect Vehicle Tuner and Subscription are required. For more information, visit the website (www.siriusxm.com).

To take full advantage of all the SiriusXM capabilities, such as TuneMix™, SportsFlash™ and Traffic & Weather Now, please use the SXV300 tuner (sold separately). Other tuners are compatible but may limit the features.

Subscribing to the SiriusXM Satellite Radio service

1 Press  then touch .

2 Touch [SiriusXM].

You should be able to tune in to Channel 1. If you cannot get Channel 1, ensure that your SiriusXM Connect Vehicle Tuner is installed correctly.

3 Switch to Channel 0 and check the Radio ID.

The SiriusXM Radio ID can be found by tuning in to Channel 0.

You will need this number to activate your subscription.

NOTE

The SiriusXM Radio ID does not include the letters I, O, S, or F.

4 Activate the service either online or by phone.

TIP

In the USA, you can activate online or by calling SiriusXM Listener Care:

- Visit the website
www.siriusxm.com/activatenow
- Call SiriusXM Listener Care at
1-866-635-2349

For Canadian subscriptions, please contact:

- Visit the website
www.xmradio.ca
and click on "ACTIVATE RADIO" at the top right corner of the page, or call (1-877-438-9677).

NOTES







- The SiriusXM satellites will send an activation message to your tuner. When the tuner has received the message, [Subscription Updated] is displayed.
- The activation process usually takes 10 to 15 minutes, but it may take up to an hour. Do not turn off this product while the activation message is displayed.

Listening to SiriusXM

- 1 Press  then touch .
- 2 Touch [SiriusXM].





Basic operation



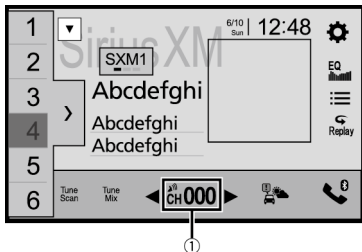









TIPS



- By pressing  then touch  or , you can move the preset channels up or down on the current channel screen, and skip files forward or backward on the play time indicator screen.
- By pressing  then touch and hold  or , you can move channels up or down on the current channel screen, and perform fast reverse or fast forward on the play time indicator screen.
- On the Featured Favorites Band, the current broadcast frequency cannot be stored to a key (page 77).
- If fewer than two music channels are stored as presets, you cannot use the TuneMix function.
- [RADIO ID] is displayed when Channel 0 is selected.

Current channel display (Live broadcast mode)









①	Selects a channel directly.
	<p> Recalls the preset channel stored to a key from the memory.</p> <p> Stores the current channel to a key.</p>
	<p>Displays the preset channels. Select an item on the list ([1] to [6]) to switch to the preset channel.</p>
	<p>Selects a band. There are 3 bands and a Featured Favorites. You can store 6 channels per band for a total of 18 presets.</p>

	<p>Performs TuneScan™ (page 76).</p>
	<p>Switches TuneMix™ to on or off. You can use TuneMix™ from each of the music channels stored as presets on the current band.</p> <p>NOTES</p> <ul style="list-style-type: none"> • When fewer than two music channels are stored as presets, you cannot use TuneMix™. • Locked channels will not be used by TuneMix™ until the channels are unlocked by entering the parental control passcode.
	<p> Performs channel number up/down.</p>
	<p> Performs fast channel number up/down.</p>
	<p>Switches to the channel broadcasting the traffic and weather information for the selected city (Traffic & Weather Now™). Touch the desired city to access the latest Traffic & Weather report for your favorite market. To cancel Traffic & Weather Now™, touch .</p> <p>TIPS</p> <ul style="list-style-type: none"> • Grayed out: Traffic and weather broadcast for your market is not yet available. • With green dot: Latest report available, but not listened to yet. • White: Latest report available to hear again. • To listen to the information again, touch  on the current channel display. • If you have not selected the city, touch  to select the city. You can also select the city in advance (page 79). • If you have already selected the city, you can listen to the information only by touching . <p>NOTES</p> <ul style="list-style-type: none"> • To use this function, select the city in advance (page 79). • The selected city can be changed in the Sirius XM settings (page 79).
	<p>Switches to Replay™ Mode.</p>

	<p>Selects a channel from the list. Select the category name or the list of all channels then touch the desired channel. To switch the display list, touch .</p> <p>TIPS</p> <ul style="list-style-type: none"> The displayed list switches in the following order. Channel Name—Artist Name—Song Title—Content Info If you touch , you can scan each channel in the selected category. When there is no category, you can select the channel from [Others]. <p>NOTES</p> <ul style="list-style-type: none"> The types of categories available depend on the types of channels available. It may take time to display the channel list depending on the SiriusXM reception condition.
---	---

Replay™ Mode (Time bar display)



	<p>Switches between playback and pause.</p>
	<p> Performs content forward or backward.</p>
	<p> Performs fast forward or rewind.</p>
	<p>Switches to live broadcast mode.</p>

TuneScan™

When you activate the TuneScan™ feature, you will hear a few seconds of the songs which have not been listened to from each of the music channels stored as presets on the current band.



NOTES

- When fewer than two music channels are stored as presets, you cannot use TuneScan™.

- TuneScan™ may take a few minutes to become available after the product is turned on or the preset band is changed.

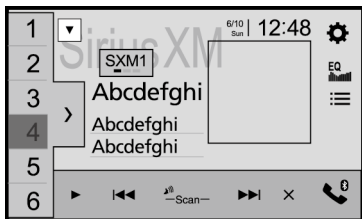
1 Touch  to display the following display.



	Continues playing the current scanning song or channel.
	Skips to the previous/next song during TuneScan™ or to the previous/next channel during category scan.
	Cancels scan play and returns to the previous channel.

SportsFlash™

SportsFlash™ will notify you when a big play happens during a game with one of your favorite sports teams.

Choose to tune in and hear the play unfold like it was live. Continue listening to the game, or you can return to your previous channel.

For details, see [SportsFlash] (page 79) and [SportsFlash List] (page 79) in SiriusXM settings.

SmartFavorites

All preset channels will buffer the content to be used for Replay, TuneStart, TuneScan and TuneMix features.

Using Featured Favorites Band

Featured Favorites are groups of channels that are created by the SiriusXM Programming department allowing you to discover new channels. Featured Favorite channels are dynamic and can change often, allowing you to discover new channels.

For details, see [Featured Favorites] and [Featured Band Update Message] in SiriusXM settings (page 78).

How to access

When there is a Featured Favorite, access it with the band key.

1 Touch the band key.

SXM1—SXM2—SXM3—FF

When there are multiple Featured Favorites, access them from the category list.

It is displayed at the bottom of the category list (page 76).

Parental lock

The Parental Control feature allows you to limit access to any SiriusXM channels, including those with mature content. When enabled, the Parental Control feature requires you to enter a passcode to tune to the locked channels.

For details, see [Parental Control] in SiriusXM settings (page 79).

SiriusXM settings

1 Press .

2 Touch  then .



The system setting screen appears.

3 Touch [AV Source Settings].

4 Touch [SiriusXM settings].

The menu items vary depending on whether SiriusXM is selected as the source.

Menu Item	Description
[Tune Start] [On] [Off]	Start songs automatically from the beginning when you tune to one of your preset channels in the current preset band when TuneStart™ is turned on.

Menu Item	Description
[Parental Control]	<p>Enter the current passcode then touch  to set this function (the default passcode is 0000).</p> <ul style="list-style-type: none"> • To edit the passcode, touch [Edit Code] then touch  followed by entering the new passcode. • To lock the channel, touch the appropriate channel.  appears and the channel is locked. <p>TIPS</p> <ul style="list-style-type: none"> • When you touch the locked channel, the channel is unlocked. • When you touch [Clear All], all locked channels are unlocked.
[Featured Favorites] [On] [Off]	<p>Set to [On] to allow you to discover new channels created by the SiriusXM Programming department.</p> <p>NOTE</p> <p>When [Featured Band Update Message] is set to [On] and the Featured Favorite Band is updated, the Featured Band Update message will appear.</p>
[Featured Band Update Message] [On] [Off]	<p>Set to [On] to be notified when the featured seasonal theme is updated.</p> <p>TIP</p> <p>To display [Featured Band Update Message] at all times, [Featured Favorites] needs to be set to [On].</p>
[SportsFlash] [On] [Off]	<p>Set to [On] to activate the SportsFlash™ function.</p> <ul style="list-style-type: none"> • Touch [Play] to listen to the notified channel. • Touch [Ignore] to stay tuned to the current channel. • Touch [Cancel] to cancel notifications regarding the game.
[SportsFlash List]	<p>Select favorite teams for SportsFlash™.</p> <ul style="list-style-type: none"> • Touch [Edit List] then select a league and team to set the favorite. <p>TIPS</p> <ul style="list-style-type: none"> • You can touch an item again to deselect it. • If you want to remove all the teams you have set, touch [Clear All]. <p>Setting of priorities</p> <p>If you set many Favorite Teams, up to 5 Favorite Teams can be received at once. Set the priorities if more than six teams are set as Favorite Teams.</p> <ol style="list-style-type: none"> 1 Touch [Prioritize] on the team selection screen. 2 Select the five high priority teams from the selected favorite teams.
[City List]	<p>Select the city for the latest traffic and weather report in Traffic & Weather Now™.</p>

Menu Item	Description
[SiriusXM Reset]	<p>Set to restore to the default Sirius XM settings by touching [Restore].</p> <p> CAUTION Do not turn off the engine while restoring the settings.</p> <p>NOTES</p> <ul style="list-style-type: none">• This setting is available only when you stop your vehicle in a safe place and apply the parking brake.• The source is turned off before the process starts.

AUX

You can display the video image output by the device connected to video input.





⚠ CAUTION

For safety reasons, video images cannot be viewed while your vehicle is in motion. To view video images, stop in a safe place and apply the parking brake.

NOTE

A Mini-jack AV cable (sold separately) is required for connection. For details, refer to the Installation Manual.

Starting procedure

- 1 Press .
- 2 Touch  then .
- 3 Touch [Input/Output settings].
- 4 Confirm that [AUX Input] is turned on.
- 5 Press  then touch .
- 6 Touch [AUX].
The AUX screen appears.

Basic operation

AUX screen

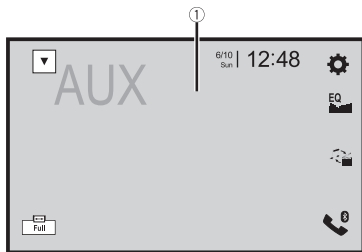

①	Hides the touch panel keys. To display the keys again, touch anywhere on the screen. TIP You can set the screen size for the video image (page 105).
	Switches between the video input and audio input.





AV input

You can display the video image output by the device connected to video or camera input. For details, refer to the Installation Manual.

CAUTION

For safety reasons, video images cannot be viewed while your vehicle is in motion. To view video images, stop in a safe place and apply the parking brake.

Starting procedure







- 1 Press .
- 2 Touch  then .
- 3 Touch [Input/Output settings].
- 4 Touch [AV Input].
- 5 Touch [On].
- 6 Press  then touch .
- 7 Touch [AV].

The video image is displayed on the screen.

Settings

You can adjust various settings in the main menu.

Displaying the setting screen

- 1 Press .
- 2 Touch .
- 3 Touch one of the following categories, then select the options.
 -  System settings (page 84)
 -  Theme settings (page 92)
 -  Audio settings (page 93)
 -  Video settings (page 100)
 -  Bluetooth settings (page 24)

System settings

The menu items vary according to the source.

[AV Source Settings]

Menu Item	Description
[Radio settings]	(page 37)
[SiriusXM settings]	(page 78)
[Bluetooth Audio] [On] [Off]	Setting Bluetooth audio source activation.
[Spotify] [On] [Off]	Setting Spotify source activation.

[Beep Tone]

Menu Item	Description
[Beep Tone] [On] [Off]	Select [Off] to disable the beep sound when the button is pressed or the screen is touched.

[Auto Mix]

Menu Item	Description
[Auto Mix] [On] [Off]	Select whether to perform mixing the sound output from WebLink and AV source sound automatically.

[Input/Output settings]

Menu Item	Description
[USB MTP] [Off] [On]	Select whether or not to activate USB MTP (Media Transfer Protocol) connection.
[WebLink Sound]	Set where the sound for WebLink is output when it is used with a smartphone. NOTE The sound may not be output from this unit when using WebLink with certain smartphone models. In this case, select [Smartphone].
[AVH]	The sound is output from the speakers of this unit.
[Smartphone]	The sound is output from the speakers of the smartphone. NOTE With an iPhone, the sound is always output from the speakers of this unit.
[AV Input] [On] [Off]	Select AV input source (page 83).
[AUX Input] [On] [Off]	Set to [On] for AUX source (page 81).

[Camera settings]

A separately sold rear view camera (e.g. ND-BC8) is required for utilizing the rear view camera function. (For details, consult your dealer.)

► Rear view camera

This product features a function that automatically switches to the full-screen image of the rear view camera installed on your vehicle when the shift lever is in the REVERSE (R) position.

Camera View mode also allows you to check what is behind you while driving.

► Camera for Camera View mode

Camera View can be displayed at all times. Note that with this setting, the camera image is not resized to fit, and that a portion of what is seen by the camera is not viewable.

To display the camera image, touch [Camera View] on the AV source selection screen (page 34).

NOTE

To set the rear view camera as the camera for Camera View mode, set [Back Camera Input] to [On] (page 86).

CAUTION

Pioneer recommends the use of a camera which outputs mirror reversed images, otherwise the screen image may appear reversed.

- Immediately verify whether the display changes to the rear view camera image when the shift lever is moved to REVERSE (R) from another position.
- When the screen changes to full-screen rear view camera image during normal driving, switch to the opposite setting in [Camera Polarity].
- If you touch  while the camera image is displayed, the displayed image turns off temporarily.

Menu Item	Description
[Back Camera Input] [Off] [On]	Setting rear view camera activation.
[Camera Polarity]	Setting the polarity of the rear view camera.
[Battery]	The polarity of the connected lead is positive.
[Ground]	The polarity of the connected lead is negative.
	NOTE This function is available when [Back Camera Input] is set to [On].
[Parking Assist Guide] [On] [Off]	You can set whether to display the parking assist guidelines on the rear view camera images when backing up your vehicle.

Menu Item	Description
[Parking Assist Guide Adjust]	<p>Adjusting the guidelines by dragging or touching ▲/▼/◀/▶/◀/▶ on the screen. Touch [Default] to reset the settings.</p> <p>⚠ CAUTION</p> <ul style="list-style-type: none"> When adjusting the guidelines, be sure to park the vehicle in a safe place and apply the parking brake. Before getting out of the car to place the markings, be sure to turn the ignition switch off (ACC OFF). The range projected by the rear view camera is limited. Also, the vehicle width and distance guidelines displayed on the rear view camera image may differ from the actual vehicle width and distance. (The guidelines are straight lines.) The image quality may deteriorate depending on the usage environment, such as at night or in dark surroundings. <p>NOTES</p> <ul style="list-style-type: none"> This setting is available only when you stop your vehicle in a safe place and apply the parking brake. Using packing tape or similar tape place markings as shown below before setting up the guidelines so that the guidelines can be overlaid to the markings.

[Demo Mode]

Menu Item	Description
[Demo Mode] [On] [Off]	Setting the demo mode.

[System Language]

Menu Item	Description
[System Language]	Select the system language.
	<p>NOTES</p> <ul style="list-style-type: none"> • If the embedded language and the selected language setting are not the same, the text information may not display properly. • Some characters may not be displayed properly.

[Auto Flap]

Menu Item	Description
[Auto Flap] [On] [Off]	Select whether or not to open/close the LCD panel automatically when the ignition switch is turned on or off.

[Restore Settings]





Menu Item	Description
[All Settings]	Touch [Restore] to restore the settings to the default settings.
	<p>⚠ CAUTION</p> <p>Do not turn off the engine while restoring the settings.</p> <p>NOTES</p> <ul style="list-style-type: none"> • This setting is available only when you stop your vehicle in a safe place and apply the parking brake. • The source is turned off and the Bluetooth connection is disconnected before the process starts. • Before starting the restore process, disconnect any device that is connected to the USB port. Otherwise, some settings may not be restored correctly.

[Touch panel calibration]

If you feel that the touch panel keys on the screen deviate from the actual positions that respond to your touch, adjust the response positions of the touch panel screen.

NOTES

- Do not use sharp pointed tools such as ballpoint or mechanical pens. They may damage the screen.
- Do not turn off the engine while saving the adjusted position data.
- This setting is available only when you stop your vehicle in a safe place and apply the parking brake.

Menu Item	Description
[Touch panel calibration]	<ol style="list-style-type: none"> 1 Touch [Yes]. 2 Touch two corners of the screen along the arrows then touch the centers of the two [+] marks at the same time twice. 3 Press . <ul style="list-style-type: none"> The adjustment results are saved. 4 Press  once again. <ul style="list-style-type: none"> Proceed to 16-point adjustment. 5 Gently touch the center of the [+] mark displayed on the screen. <ul style="list-style-type: none"> The target indicates the order. <ul style="list-style-type: none"> • When you press , the previous adjustment position returns. • When you press and hold , the adjustment is canceled. 6 Press and hold . <ul style="list-style-type: none"> The adjustment results are saved.

[Dimmer Settings]

NOTE

This setting is available only when you stop your vehicle in a safe place and apply the parking brake.

Menu Item	Description
[Dimmer Trigger]	Setting the dimmer brightness.
[Auto]	Switches the dimmer to on or off automatically according to your vehicle's headlight turning on or off.
[Manual]	Switches the dimmer to on or off manually.
[Time]	Switches the dimmer to on or off at the time you adjusted.
[Day/Night]	Setting the dimmer duration by day or night. You can use this function when [Dimmer Trigger] is set to [Manual].
[Day]	Turns the dimmer function to off.
[Night]	Turns the dimmer function to on.

Menu Item	Description
[Dimmer Duration]	<p>Adjust the time that the dimmer is turned on or off by dragging the cursors or touching ◀ or ▶.</p> <p>You can use this function when [Dimmer Trigger] is set to [Time].</p> <p>TIPS</p> <ul style="list-style-type: none"> • Each touch of ◀ or ▶ moves the cursor backward or forward in the 15 minute width. • When the cursors are placed on the same point, the dimmer available time is 0 hours. • When the cursor for off time setting is placed on the left end and the cursor for on time setting is placed on the right end, the dimmer available time is 0 hours. • When the cursor for on time setting is placed on the left end and the cursor for off time setting is placed on the right end, the dimmer available time is 24 hours. <p>NOTE</p> <p>The time display of the dimmer duration adjusting bar depends on the clock display setting (page 105).</p>

[Driving Position]

Menu Item	Description
[Driving Position] [Right] [Left]	<p>Setting the driving position.</p> <ul style="list-style-type: none"> • Apple CarPlay™ (page 59) • Android Auto™ (page 62)

[Android Auto Auto-launch]

Menu Item	Description
[Android Auto Auto-launch] [On] [Off]	<p>Select [On] to automatically launch Android Auto when an Android device is connected to the unit.</p>

[Picture Adjustment]

You can adjust the picture for each source and rear view camera.

CAUTION

For safety reasons, you cannot use some of these functions while your vehicle is in motion. To enable these functions, you must stop in a safe place and apply the parking brake.

To adjust following menu, touch ◀, ▶, ▲, ▼ to adjust.

Menu Item	Description
[Brightness] [-24] to [+24]	Adjust the black intensity.
[Contrast] [-24] to [+24]	Adjust the contrast.
[Color]* [-24] to [+24]	Adjust the color saturation.
[Hue]* [-24] to [+24]	Adjust the tone of color (which color is emphasized, red, or green).
[Dimmer] [+1] to [+48]	Adjust the brightness of the display.
[Temperature] [-3] to [+3]	Adjust the color temperature, resulting in a better white balance.

* With some pictures, you cannot adjust [Hue] and [Color].

NOTES

- The adjustments of [Brightness], [Contrast], and [Dimmer] are stored separately when your vehicle's headlights are off (daytime) and on (nighttime).
- [Brightness] and [Contrast] are switched automatically depending on the setting of [Dimmer Settings].
- [Dimmer] can be changed the setting or the time to switch it to on or off (page 89).
- The picture adjustment may not be available with some rear view cameras.
- The setting contents can be memorized separately.

[System Information]









Menu Item	Description
[Firmware Information]	Displaying the firmware version.

Menu Item	Description
[Firmware Update]	<p>⚠ CAUTION</p> <ul style="list-style-type: none"> • The USB storage device for updating must contain only the correct update file. • Never turn this product off, disconnect the USB storage device while the firmware is being updated. • You can only update the firmware when the vehicle is stopped and the parking brake is engaged. <ol style="list-style-type: none"> 1 Download the firmware update files into your computer. 2 Connect a blank (formatted) USB storage device to your computer then locate the correct update file and copy it onto the USB storage device. 3 Connect the USB storage device to this product (page 44). 4 Turn the source off (page 34). 5 Display the [System] setting screen (page 84). 6 Touch [System Information]. 7 Touch [Firmware Update]. 8 Touch [Continue]. <p>Follow the on-screen instructions to finish updating the firmware.</p> <p>NOTES</p> <ul style="list-style-type: none"> • This product will reset automatically after the firmware update is completed if the update is successful. • If an error message appears on the screen, touch the display and perform the above steps again.
[License]	Displaying the open source license.

Theme settings

The menu items vary according to the source.

Menu Item	Description
[Background]	<p>Select the wall paper from the preset items in this product or original pictures via the external device.</p> <p>The wall paper can be set from selections for the top menu screen and AV operation screen.</p> <p>TIP</p> <p>The preset image located on the far left changes randomly depending on the playback song and the station.</p>
Preset Display	Select the desired preset background display.

Menu Item	Description
 (custom)*1	Displays the background display image imported from the external storage device.
 (off)	Hides the background display.
[Illumination]*2	Select an illumination color from the color list or create a defined color.
Colored Keys	Select the desired preset color.
 (custom)	Displays the screen to customize the illumination color. To customize the defined color, touch  then touch  or  to adjust the brightness and the level of red, green and blue to create favorite color. To store the customized color in the memory, touch and hold [Memo], and the customized color will be available at the next illumination setting by touching  .
	TIP You can also adjust the color tone by dragging the color bar.
 (rainbow)	Shifts gradually between the preset colors in sequence.
[Theme]*2	Select the theme color.
[Clock]	Select the style of the clock from the preset image.
Preset Images	Select the desired preset style for the clock.
 (off)	Hides the clock display.
[Home Custom Settings]	Customize the top menu screen of the following items. <ul style="list-style-type: none"> • Switch the top menu screen layout • Display/hide the artwork • Adjust the range of the favorite application/source area







*1 Refer to Still image source (page 49).

*2 You can preview the top menu screen or the AV operation screen by touching [Home] or [AV] respectively.

Audio settings

The menu items vary according to the source. Some of the menu items become unavailable when the volume is set to mute.

Menu Item	Description
[Graphic EQ] [Super Bass (S.Bass)] [Powerful] [Natural] [Vocal] [Flat] [Custom1] [Custom2]	Select or customize the equalizer curve. Select a curve that you want to use as the basis of customizing then touch the frequency that you want to adjust. TIPS <ul style="list-style-type: none"> • If you make adjustments when a curve [S.Bass (Super Bass)], [Powerful], [Natural], [Vocal], or [Flat] is selected, the equalizer curve settings will be changed to [Custom1] mandatorily. • If you make adjustments when the [Custom2] curve is selected for example, the [Custom2] curve will be updated. • [Custom1] and [Custom2] curves can be created common to all sources. • If you trail a finger across the bars of multiple equalizer bands, the equalizer curve settings will be set to the value of the touched point on each bar.
[Fader/Balance]	Touch ▲ or ▼ to adjust the front/rear speaker balance. Set [Front] and [Rear] to [0] when using a dual speaker system. Touch ◀ or ▶ to adjust the left/right speaker balance. TIP You can also set the value by dragging the point on the displayed table. NOTE Only the balance can be adjusted when [Network Mode] is selected as the speaker mode.
[Mute Level]	Select mute or attenuate the AV source volume and iPhone or smartphone application volume when the navigation outputs the guidance voice.
[ATT]	The volume becomes 20 dB lower than the current volume.
[Mute]	The volume becomes 0.
[Off]	The volume does not change.

Menu Item	Description
[Source Level Adjuster] [-4] to [+4]	Adjust the volume level of each source to prevent radical changes in volume when switching between sources other than FM. Touch  or  to adjust the source volume after comparing the FM tuner volume level with the level of the source. TIP If you directly touch the area where the cursor can be moved, the SLA (source level adjustment) setting will be changed to the value of the touched point. NOTES <ul style="list-style-type: none"> • Settings are based on the FM tuner volume level, which remains unchanged. • This function is not available when the FM tuner is selected as the AV source.
[Subwoofer] [On] [Off]	Select enable or disable rear subwoofer output from this product.
[Speaker Level] Listening Position*1*2 [Off] [Front Left] [Front Right] [Front] [All] Standard Mode*3 [Front Left] [Front Right] [Rear Left] [Rear Right] [Subwoofer] Network Mode*3 [High Left] [High Right] [Mid Left] [Mid Right] [Subwoofer] Speaker output level [-24] to [10]	Adjust the speaker output level of the listening position. 1 Touch  or  to select the listening position then select the output speaker. 2 Touch  or  to adjust the selected speaker output level. NOTE This function is available when [Subwoofer] is set to [On].
[Crossover]*4	Select a speaker unit (filter) to adjust the HPF or LPF cutoff frequency and the slope for each speaker unit (page 99).
[Subwoofer Settings]*4	Select the subwoofer phase (page 99).
[Listening Position]*1 [Off] [Front Left] [Front Right] [Front] [All]	Select a listening position that you want to make as the center of sound effects.

Menu Item	Description
[Time Alignment] [On] [Off] Listening Position*1*2 [Off] [Front Left] [Front Right] [Front] [All] Standard Mode*3*5 [Front Left] [Front Right] [Rear Left] [Rear Right] [Subwoofer] Network Mode*3*5 [High Left] [High Right] [Mid Left] [Mid Right] [Subwoofer] Distance [0] to [140]	Select or customize the time alignment settings to reflect the distance between the listener's position and each speaker. You need to measure the distance between the head of the listener and each speaker unit. 1 Touch ◀ or ▶ to select the listening position then select the alignment speaker. 2 Touch ◀ or ▶ to input the distance between the selected speaker and listening position. TIP If you touch [TA On], the time alignment is turned off mandatorily. NOTE This function is available only when the listening position setting is set to [Front Left] or [Front Right].
[Auto EQ] [On] [Off]	Set the auto-adjusted equalizer to suit the vehicle's acoustics. To use this function, the Auto EQ measurement must be done in advance (page 98).
[A-EQ&TA Measurement]	Measures and adjusts the vehicles acoustics, equalizer, and time alignment automatically to suit the vehicle interior (page 98).
[Save Settings]	Save to recall the following current sound settings by touching [OK]: slope, subwoofer phase, speaker level, Graphic EQ, HPF/LPF, listening position, crossover, time alignment. TIP When you touch [Cancel], return to the [Audio] setting screen.
[Load Settings] [Initial Settings] [Sound Setting] [Auto EQ&TA Setting]	Load the sound settings. NOTES <ul style="list-style-type: none"> • [Sound Setting] is available only when you have already saved the sound settings (page 96). • [Auto EQ&TA Setting] is available only when you have already performed Auto EQ measurement (page 97).
[BASS Boost] [0] to [6]	Adjust the bass boost level.
[Rear Speaker Output] [Rear] [Subwoofer]	Select the rear speaker output. NOTE This function is available when [Standard Mode] is selected as the speaker mode.
[Loudness] [Off] [Low] [Mid] [High]	Compensates for deficiencies in the low-frequency and high-frequency ranges at low volume.

Menu Item	Description
[Automatic Level Control]	Corrects automatically the audio level difference between the music files or the sources.
[Off]	Turns the auto level control setting off.
[Mode1]	Corrects a little the audio level difference between the music files or the sources (for the narrow dynamic range audio signal).
[Mode2]	Corrects widely the audio level difference between the music files or the sources (for the wide dynamic range audio signal).
[Sound Retriever] [Off] [Mode1] [Mode2]	Enhances compressed audio and restores rich sound automatically. TIP [Mode2] has a stronger effect than [Mode1].

- *1 [All] is not available when [Network Mode] is selected as the speaker mode.
- *2 If you change the listening position setting, the output levels of all the speakers will change in conjunction with the setting.
- *3 To use this function, the vehicle's acoustics must be measured in advance.
- *4 This function is not available when adjusting the High speaker.
- *5 This function is available only when the listening position setting is set to [Front Left] or [Front Right].

Adjusting the equalizer curve automatically (Auto EQ)

By measuring the vehicle's acoustics, the equalizer curve can be adjusted automatically to suit the vehicle interior.

WARNING

A loud tone (noise) may be emitted from the speakers when measuring the vehicle's acoustics. Never perform Auto EQ measurement while driving.

CAUTION

- Thoroughly check the conditions before performing Auto EQ as the speakers may be damaged if this is performed under the following conditions:
 - When the speakers are incorrectly connected. (For example, when a rear speaker is connected as a subwoofer output.)
 - When a speaker is connected to a power amp delivering output higher than the speaker's maximum input power capability.
- If a microphone for acoustical measurement (sold separately) is not placed in the appropriate location, the measurement tone may become loud and measurement may take a long time, resulting in battery drainage. Be sure to place the microphone in the specified location.

► Before operating the Auto EQ function

- Perform Auto EQ in a quiet place with the vehicle engine and air conditioning switched off. Also, cut the power of car phones or cellular phones in the vehicle, or remove them in advance. Surrounding sounds may prevent correct measurement of the vehicle's acoustics.
- Be sure to use the microphone for acoustical measurement (sold separately). Using other microphones may prevent measurement, or result in incorrect measurement of the vehicle's acoustics.
- To perform Auto EQ, the front speakers must be connected.
- When this product is connected to a power amp with input level control, Auto EQ may be impossible if the power amp's input level is set below the standard level.
- When this product is connected to a power amp with an LPF (low pass filter), turn the LPF off before performing Auto EQ. Also, set the cutoff frequency for the built-in LPF of an active subwoofer to the highest frequency.
- The distance has been calculated by a computer to provide optimum delay to ensure accurate results. Do not change this value.
 - The reflected sound within the vehicle is strong and delay occurs.
 - The LPF on active subwoofers or external amps delay the lower sounds.
- If an error occurs during measurement, check the following before measuring the vehicle's acoustics.
 - Front speakers (left/right)
 - Rear speakers (left/right)
 - Noise
 - Microphone for acoustical measurement (sold separately)
 - Low battery

► Performing Auto EQ



CAUTION

Do not turn off the engine while the measurement is in progress.

NOTES

- Auto EQ changes the audio settings as follows:
 - The fader/balance settings return to the center position (page 94).
- Previous settings for Auto EQ will be overwritten.

1 Stop the vehicle in a quiet place, close all doors, windows, and sun roof, and then turn the engine off.



If the engine is left running, engine noise may prevent correct Auto EQ.

NOTE

If driving restrictions are detected during measurement, the measurement is canceled.

2 Fix the microphone for acoustical measurement (sold separately) in the center of the headrest of the driver's seat, facing forward.

The Auto EQ may differ depending on where you place the microphone. If desired, place the microphone on the front passenger seat and perform Auto EQ.

- 3 Disconnect the iPhone or smartphone device.
- 4 Turn on the ignition switch (ACC ON).
If the vehicle's air conditioner or heater is turned on, turn it off.
- 5 Switch the AV source to [Source OFF] (page 34).
- 6 Press .
- 7 Touch  then .
- 8 Touch [A-EQ&TA Measurement].
- 9 Connect the microphone for acoustical measurement (sold separately) with this product.
Plug the microphone into the AUX input jack on the back panel of this product.

NOTE

Use an extension cable (sold separately) if the cord of the microphone (sold separately) is not long enough.

- 10 Touch [Front Left] or [Front Right] to select the current listening position.
- 11 Touch [Start].
A 10-second countdown starts.

NOTE

The Bluetooth connection is disconnected before the process starts.

- 12 Exit the vehicle and keep the doors closed until the countdown finishes.
When the countdown finishes, a measurement tone (noise) is emitted from the speakers and Auto EQ measurement begins.
- 13 Wait until the measurement is completed.
When Auto EQ is completed, a message is displayed.

NOTE

The measurement time varies depending on the type of vehicle.

TIP

To stop the measurement, touch [Stop].

- 14 Store the microphone carefully in the glove compartment or another safe place.
If the microphone is subjected to direct sunlight for an extended period, high temperatures may cause distortion, color change, or malfunction.

Adjusting the cutoff frequency value

You can adjust the cutoff frequency value of each speaker.





The following speakers can be adjusted:

[Standard Mode]: Front, Rear, Subwoofer.

[Network Mode]: High, Mid, Subwoofer.

NOTE

[Subwoofer Settings] is available only when [Subwoofer] is [On].

- 1 Press .
- 2 Touch  then .
- 3 Touch [Crossover] or [Subwoofer Settings].
- 4 Touch  or  to switch the speaker.
- 5 Drag the graph line to set the cutoff position.
- 6 Drag the lowest point of the graph to set the cutoff slope.
The following items can also be set.

	Switches the subwoofer phase between normal and reverse position.
LPF/HPF	Switches the LPF/HPF setting to [On] or [Off]. When it is turned off, the high-pass filter or low-pass filter of each speaker can also be turned on by touching the graph lines.







Video settings



The menu items vary according to the source.

[DVD Setup]

This setting is available when the selected source is [Disc], [CD], [Video CD] or [DVD].

Menu Item	Description
[Subtitle Language]*1*2*3	Set a subtitle language preference. When you select [Others], a language code input screen is shown. Input the four-digit code of the desired language then touch  .
[Audio Language]*1*2*3	Set an audio language preference. When you select [Others], a language code input screen is shown. Input the four-digit code of the desired language then touch  .
[Menu Language]*1*2*3	Set a menu language preference. When you select [Others], a language code input screen is shown. Input the four-digit code of the desired language then touch  .
[Multi Angle] [On] [Off]	Set to display the angle icon on the screen.

Menu Item	Description
[TV Aspect]	<p>Set the aspect ratio suitable for your rear display 16:9 (wide screen display) or 4:3 (regular display). (We recommend use of this function only when you want to fit the aspect ratio to the rear display.)</p> <p>NOTES</p> <ul style="list-style-type: none"> • When using a regular display, select either [Letter Box] or [Pan Scan]. Selecting [16:9] may result in an unnatural image. • If you select the TV aspect ratio, this product's display will change to the same setting. • When playing discs that do not have a panscan system, the disc is played back with [Letter Box] even if you select the [Pan Scan] setting. Confirm whether the disc package bears the  mark. • The TV aspect ratio cannot be changed for some discs. For details, refer to the disc's instructions.
[16:9]	Displays the wide screen image (16:9) as it is (initial setting).
[Letter Box]	Makes the image in the shape of a letterbox with black bands on the top and bottom of the screen.
[Pan Scan]	Cuts the image short on the right and left sides of the screen.

Menu Item	Description
[Parental]	<p>Set restrictions so that children cannot watch violent or adult-oriented scenes. You can set the parental lock level in steps as desired.</p> <ol style="list-style-type: none"> 1 Touch [0] to [9] to input a four-digit code number. 2 Touch . Registers the code number, and you can now set the level. 3 Touch any number between [1] to [8] to select the desired level. The lower the level is set, the tighter the restriction is applied. 4 Touch . Sets the parental lock level. <p>NOTES</p> <ul style="list-style-type: none"> • We recommend keeping a record of your code number in case you forget it. • The parental lock level is recorded on the disc. You can confirm it by looking at the disc package, the included booklet, or the disc itself. You cannot use parental lock with discs that do not feature a recorded parental lock level. • With some discs, parental lock operates to skip certain scenes only, after which normal playback resumes. For details, refer to the disc's instructions.
[DVD Auto Play] [On] [Off]	<p>Set to display the DVD menu automatically and start playback from the first chapter of the first title when a DVD disc with a DVD menu is inserted.</p> <p>NOTE</p> <p>Some DVDs may not operate properly. If this function is not fully operable, turn this function off and start playback.</p>

*1 You can switch the language by touching the switch languages key during playback.

*2 The setting made here will not be affected even if the language is switched during playback using the appropriate key.

*3 If the selected language is not available, the language specified on the disc is displayed.

[Time Per Photo Slide]

Menu Item	Description
[Time Per Photo Slide] [5sec] [10sec] [15sec] [Manual]	Select the interval of image file slideshows on this product.

[Video Signal Setting]

Menu Item	Description
[AV] [Auto] [PAL] [NTSC] [PAL-M] [PAL-N] [SECAM]	Select the suitable video signal setting when you connect this product to an AV equipment.
[AUX] [Auto] [PAL] [NTSC] [PAL-M] [PAL-N] [SECAM]	Select the suitable video signal setting when you connect this product to an AUX equipment.
[Camera] [Auto] [PAL] [NTSC] [PAL-M] [PAL-N] [SECAM]	Select the suitable video signal setting when you connect this product to a rear view camera.



Favorite menu

Registering your favorite menu items in shortcuts allows you to quickly jump to the registered menu screen by a simple touch on the [Favorites] screen.

NOTE

Up to 12 menu items can be registered in the favorite menu.

Creating a shortcut

- 1 Press  then touch .
- 2 Touch the star icon of the menu item.
The star icon for the selected menu is filled in.

TIP

To cancel the registration, touch the star icon in the menu column again.

Selecting a shortcut

- 1 Press  then touch .
- 2 Touch .
- 3 Touch the menu item.

Removing a shortcut



- 1 Press  then touch .
- 2 Touch .
- 3 Touch and hold the favorite menu column.
The selected menu item is removed from the [Favorites] screen.

TIP

You can also remove a shortcut by touching and holding the registered menu column.

Other functions

Setting the time and date

- 1 Touch the current time on the screen.
- 2 Touch  or  to set the correct time and date.
You can operate the following items: Year, month, date, hour, minute.

TIPS

- You can change the time display format to [12hour] or [24hour].
- You can change the order of date display format: Day-month, Month-day.

Changing the wide screen mode

You can set the screen mode for AV screen and image files.

- 1 Touch the screen display mode key.

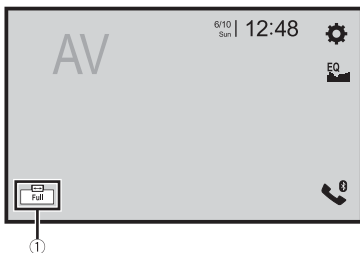

①

Screen display mode key

- 2 Touch the desired mode.

[Full]	Displays images across the entire screen. NOTE Some images may not be displayed across the entire screen.
[Zoom]	Displays the images enlarging them vertically.
[Normal]	Displays images without changing the ratio.

[Trimming]	An image is displayed across the entire screen with the horizontal-to-vertical ratio left as is. If the screen ratio differs from the image, the image may be displayed partly cut off either at the top/bottom or sides. NOTE [Trimming] is for image files only.
------------	---

TIPS

- Different settings can be stored for each video source.
- When a video is viewed in wide screen mode that does not match its original aspect ratio, it may appear different.
- The video image will appear coarser when viewed in [Zoom] mode.

NOTES

- Image files can be set to either [Normal] or [Trimming] in wide screen mode.
- Depending on the software version of this unit, this function may vary.

Restoring this product to the default settings

You can restore settings or recorded content to the default settings from [Restore Settings] in the [System] menu (page 88).

Appendix

Troubleshooting

If you have problems operating this product, refer to this section. The most common problems are listed below, along with likely causes and solutions. If a solution to your problem cannot be found here, contact your dealer or the nearest authorized Pioneer service facility.

Common problems

A black screen is displayed, and operation is not possible using the touch panel keys.

- [Power OFF] mode is on.
 - Press any button on this product to release the mode.

Problems with the AV screen

CD or DVD playback is not possible.

- The disc is inserted upside down.
 - Insert the disc with the label upward.
- The disc is dirty.
 - Clean the disc.
- The disc is cracked or otherwise damaged.
 - Insert a normal, round disc.
- The files on the disc are in an irregular file format.
 - Check the file format.
- The disc format cannot be played back.
 - Replace the disc.
- The loaded disc is a type this product cannot play.
 - Check what type of disc it is.

The screen is covered by a caution message and the video cannot be shown.

- The parking brake lead is not connected or the parking brake is not applied.
 - Connect the parking brake lead correctly, and apply the parking brake.
- The parking brake interlock is activated.
 - Park your vehicle in a safe place and apply the parking brake.

No video output from the connected equipment.

- The [AV Input] or [AUX Input] setting is incorrect.
 - Correct the settings.

The audio or video skips.

- This product is not firmly secured.
 - Secure this product firmly.

No sounds are produced. The volume level will not rise.

- Cables are not connected correctly.
 - Connect the cables correctly.
- The system is performing still, slow motion, or frame-by-frame playback with DVD-Video.
 - There is no sound during still, slow motion, or frame-by-frame playback with DVD-Video.
- The system is paused or performing fast reverse or forward during the disc playback.
 - For the media other than music CD (CD-DA), there is no sound on fast reverse or forward.

The icon  is displayed, and operation is impossible.

- The operation is not compatible with the video configuration.

- The operation is not possible. (For example, the DVD playing does not feature that angle, audio system, subtitle language, etc.)

Random playback in Music Browse mode is released in the USB storage device.

- Random playback in Music Browse mode is canceled after the ignition switch is turned off (ACC OFF).
- Switch to Music Browse mode again and turn on random playback.

The picture stops (pauses) and this product cannot be operated.

- The reading of data is impossible during disc playback.
- Stop playback once, then restart.

The picture is stretched, with an incorrect aspect ratio.

- The aspect setting is incorrect for the display.
- Select the appropriate setting for that image.

A parental lock message is displayed and DVD playback is not possible.

- The parental lock is on.
- Turn the parental lock off or change the level.

The parental lock for DVD playback cannot be canceled.

- The code number is incorrect.
- Input the correct code number.

Playback is not with the audio language and subtitle language settings selected in [DVD Setup].

- The DVD playing does not feature dialog or subtitles in the language selected in [DVD Setup].
- Switching to a selected language is not possible if the language selected in [DVD Setup] is not recorded on the disc.

The picture is extremely unclear/distorted and dark during playback.

- The disc features a signal to prohibit copying. (Some discs may have this.)
- Since this product is compatible with the copy guard analog copy protect system, the picture may suffer from horizontal stripes or other imperfections when a disc with that kind of protection signal is viewed on some displays. This is not a malfunction.

iPod cannot be operated.

- The iPod is frozen.
- Reconnect the iPod with the USB interface cable for iPod/iPhone.
- Update the iPod software version.
- An error has occurred.
- Reconnect the iPod with the USB interface cable for iPod/iPhone.
- Park your vehicle in a safe place, and then turn off the ignition switch (ACC OFF). Subsequently, turn the ignition switch to on (ACC ON) again.
- Update the iPod software version.
- Cables are not connected correctly.
- Connect the cables correctly.

Sound from the iPod cannot be heard.

- The audio output direction may switch automatically when the Bluetooth and USB connections are used at the same time.
- Use the iPod to change the audio output direction.

No back camera image when the vehicle is in reverse.

- The back camera input setting on the receiver is set to Off.
- Change the back camera setting to On in the settings menu. (Refer to the System Settings section of this manual to adjust.)

- The camera input may be loose or not connected.
 - Check the connection and make sure the male end of the camera is connected to the brown input on the back of the receiver. (Refer to the installation manual.)
 - The reverse lead on the receiver may not be connected to the proper wire at the reverse lamp.
 - Check the connection and make sure that the violet/white lead of the receiver is connected to the lead whose voltage changes when the shift lever is put in reverse. (Refer to the installation manual.)
-
- Problems with Application screen**
-

Black screen displayed when the vehicle is in reverse, with no camera installed.

- Back camera input is set to On.
 - Turn the setting to Off in the settings menu. (Refer to the System Settings section of this manual to adjust.)
-

Back image displayed when vehicle is not in reverse.

- The camera polarity is not set properly in the Camera settings menu.
 - Review System Settings section of this manual for steps to switch the camera polarity. Park in a safe place, then while keeping your foot firmly on the brake, put the vehicle in reverse, access the System Settings menu, and change the camera polarity setting. Put vehicle back in park. (Refer to the System Settings section of this manual to adjust.)
-

Problems with the phone screen

Dialing is impossible because the touch panel keys for dialing are inactive.

- Your phone is out of range for service.
 - Retry after re-entering the range for service.
-

- The connection between the cellular phone and this product cannot be established.
 - Perform the connection process.
 - Of the two cellular phones connected to this product at the same time, if the first phone is dialing, ringing or a call is in progress, dialing cannot be performed on the second phone.
 - When the operation on the first of the two cellular phones is completed, use the switch devices key to switch to the second phone and then dial.
-

Problems with Application screen

A black screen is displayed.

- While operating an application, the application was ended on the smartphone side.
 - Press  to display the top menu screen.
 - The smartphone OS may be awaiting screen operation.
 - Stop the vehicle in a safe place and check the screen on the smartphone.
-

The screen is displayed, but operation does not work at all.

- An error has occurred.
 - Park your vehicle in a safe place, and then turn off the ignition switch (ACC OFF). Subsequently, turn the ignition switch to on (ACC ON) again.
 - When an Android device is connected, disconnect the Bluetooth connection from this product and then reconnect it.
-

The smartphone was not charged.

- Charging stopped because the temperature of the smartphone rose due to prolonged use of the smartphone during charging.
-

- Disconnect the smartphone from the cable, and wait until the smartphone cools down.
- More battery power was consumed than was gained from charging.
 - This problem may be resolved by stopping any unnecessary services on the smartphone.

Sound from WebLink of the Android device cannot be heard from the speakers of this unit.

- Depending on the Android device, the sound from WebLink may not be output from the speakers of this unit.
 - Switch to [Smartphone] in the [WebLink Sound] settings (page 85).

Error messages

When problems occur with this product, an error message appears on the display. Refer to the table below to identify the problem, then take the suggested corrective action. If the error persists, record the error message and contact your dealer or your nearest Pioneer service center.

Common

AMP Error

- This product fails to operate or the speaker connection is incorrect; the protective circuit is activated.
 - Check the speaker connection. If the message fails to disappear even after the engine is switched off/on, contact your dealer or an authorized Pioneer Service Station for assistance.

Pandora

Error-19

(Communication error occurred.)

- Communication failed.
 - Disconnect the cable from the iPod. Once the iPod's main menu is displayed, reconnect the iPod and reset it.

Our content licenses limit the number of tracks you may skip.

- Skip limit reached.
 - Do not exceed the skip limit.
 - Pandora limits the total number of skips per hour.

Log in error

- You are not logged in to the Pandora application.
 - Please log in to the Pandora application.

Check USB

- The USB connector or USB cable has short-circuited.
 - Check that the USB connector or USB cable is not caught in something or damaged.
- The connected USB storage device consumes more than maximum allowable current.
 - Disconnect the USB storage device and do not use it. Turn the ignition switch to OFF, then to ACC or ON and then connect a compliant USB storage device.

Poor network connection. Listening will resume when it's restored.

- The Pandora application is accessed/relocated from outside the licensing region.
 - Access Pandora from within the licensing region.

Spotify

Skip limit reached.

- Skip limit reached.
 - Do not exceed the skip limit.

- Spotify limits the total number of skips per hour.

Check USB

- The USB connector or USB cable has short-circuited.
 - Check that the USB connector or USB cable is not caught in something or damaged.
- The connected USB storage device consumes more than maximum allowable current.
 - Disconnect the USB storage device and do not use it. Turn the ignition switch to OFF, then to ACC or ON and then connect a compliant USB storage device.

No Spotify

- The Spotify application is not installed in the connected device.
 - Install the Spotify application in your mobile device.

Update App

- The Spotify application is out of date.
 - Update to the latest Spotify application.

Login Please

- You are not logged in to the Spotify application.
 - Please log in to the Spotify application.

No Signal

- The connected device is out of area.
 - Connect the device to a network.

SiriusXM® Satellite Radio

Check Antenna

- The antenna connection is incorrect.
 - Check the antenna connection. If the message fails to disappear even after the engine is switched off/on, contact

your dealer or the nearest authorized Pioneer service center for assistance.

Check Tuner

- The SiriusXM Connect Vehicle Tuner connection is incorrect.
 - Check the tuner connection and battery voltage. If the message fails to disappear even after the engine is switched off/on, contact your dealer or the nearest authorized Pioneer service center for assistance.

No Signal

- The SiriusXM Connect Vehicle Tuner is having difficulty receiving the SiriusXM satellite signal.
 - Verify that your vehicle is outdoors with a clear view of the southern sky.
 - Verify that the SiriusXM magnetic mount antenna is mounted on a metal surface on the outside of the vehicle.
 - Move the SiriusXM antenna away from any obstructions.

No Content

- TuneScan™ is not available.
 - Perform the operation with another preset channel.

Channel Not Available

- The channel that you have requested is not a valid SiriusXM channel.
 - Visit www.siriusxm.com for more information about the SiriusXM channel lineup.

Subscription Updated Press Enter to Continue

- This product has detected a change in your SiriusXM subscription status.
 - Touch [Enter] to clear the message. In the U.S.A., visit www.siriusxm.com or call 1-866-635-2349 if you have questions about your subscription. In Canada, visit www.siriusxm.ca or call 1-877-438-9677 if you have questions about your subscription.

Channel Not Subscribed. Call SiriusXM to Subscribe.

- The channel that you have requested is not included in your SiriusXM subscription package.
 - Check the content of your SiriusXM subscription package.
 - In the U.S.A., visit www.siriusxm.com or call 1-866-635-2349 if you have questions about your subscription package or would like to subscribe to this channel. In Canada, visit www.siriusxm.ca or call 1-877-438-9677.

Channel Locked Please Enter the Lock Code

- Locked by the radio Parental Control feature.
 - Release the channel lock.

Memory Full

- The memory has become full while playback was paused.
 - Resume playback.

Memory Nearly Full

- The memory has become nearly full while playback was paused.
 - Resume playback.

There are no qualified TuneMix music

- There are no qualified TuneMix channels in this band.
 - Requires two or more qualified music channels to be stored as presets in the current band.

Disc**Error-02-XX/FF-FF**

- The disc is dirty.
 - Clean the disc.
- The disc is scratched.
 - Replace the disc.
- The disc is loaded upside down.

- Check that the disc is loaded correctly.
- There is an electrical or mechanical error.
 - Press the RESET button.

Different Region Disc

- The disc does not have the same region number as this product.
 - Replace the DVD with one bearing the correct region number.

Unplayable Disc

- This type of disc cannot be played on this product.
 - Replace the disc with one that can be played on this product.

Unplayable File

- This type of file cannot be played on this product.
 - Select a file that can be played.

Skipped

- The inserted disc contains DRM protected files.
 - The protected files are skipped.

Protect

- All the files on the inserted disc are embedded with DRM.
 - Replace the disc.

TEMP

- The temperature of this product is outside the normal operating range.
 - Wait until this product returns to a temperature within the normal operating limits.

Your device is not authorized to play this DivX protected video.

- This product cannot play copy-protected DivX files.
 - Select a file that can be played.

Video frame rate not supported

- DivX file's frame rate is more than 30 fps.
 - Select a file that can be played.

Audio Format not supported

- This type of file is not supported on this product.
- Select a file that can be played.

USB storage device

Error-02-9X/-DX

- Communication failed.
 - Turn the ignition switch OFF and back ON.
 - Disconnect the USB storage device.
 - Change to a different source. Then, return to the USB storage device.

Unplayable File

- There is no playable file in the USB storage device.
 - Check that the files in the USB storage device are compatible with this product.
- Security for the connected USB storage device is enabled.
 - Follow the USB storage device instructions to disable security.

Skipped

- The connected USB storage device contains DRM protected files.
 - The protected files are skipped.

Protect

- All the files on the connected USB storage device are embedded with DRM.
 - Replace the USB storage device.

Incompatible USB

- The connected USB storage device is not supported by this product.
 - Disconnect your device and replace it with a compatible USB storage device.

Check USB

- The USB connector or USB cable has short-circuited.

- Check that the USB connector or USB cable is not caught in something or damaged.

- The connected USB storage device consumes more than maximum allowable current.
 - Disconnect the USB storage device and do not use it. Turn the ignition switch to OFF, then to ACC or ON and then connect a compliant USB storage device.

HUB Error

- The connected USB hub is not supported by this product.
 - Directly connect the USB storage device to this product.

No Response

- This product cannot recognize the connected USB storage device.
 - Disconnect the device and replace it with another USB storage device.

USB was disconnected for device protection. Do not re-insert this USB memory into the unit. Please restart the unit.

- The USB connector or USB cable has short-circuited.
 - Check that the USB connector or USB cable is not caught in something or damaged.
- The connected USB storage device consumes more than maximum allowable current.
 - Disconnect the USB storage device and do not use it. Turn the ignition switch to OFF, then to ACC or ON and then connect a compliant USB storage device.
- The USB interface cable for iPod/iPhone has short-circuited.
 - Confirm that the USB interface cable for iPod/iPhone or USB cable is not caught in something or damaged.

Your device is not authorized to play this DivX protected video.

- This product cannot play copy-protected DivX files.
 - Select a file that can be played.

Audio Format not supported

- This type of file is not supported on this product.
 - Select a file that can be played.

iPod

Error-02-6X/-9X/-DX

- iPod failure.
 - Disconnect the cable from the iPod. Once the iPod's main menu is displayed, reconnect the iPod and reset it.

Error-02-67

- The iPod firmware version is old.
 - Update the iPod version.

Bluetooth

Error-10

- The power failed for the Bluetooth module of this product.
 - Turn the ignition switch to OFF and then to ON.

If the error message is still displayed after performing the above action, please contact your dealer or an authorized Pioneer Service Station.

Apple CarPlay

Attempting to connect to Apple CarPlay.

- Communication failed and the system is trying to connect.
- Wait for a while. Then, perform the actions below if the error message is still displayed.

- Restart the iPhone.
- Disconnect the cable from the iPhone, and then connect the iPhone again after a few seconds.
- Turn the ignition switch to OFF and then to ON.

If the error message is still displayed after performing the above action, please contact your dealer or an authorized Pioneer Service Station.

Android Auto

Android Auto has stopped.

- The connected device is not compatible with Android Auto.
 - Check if the device is compatible with Android Auto.
- The startup of Android Auto failed for some reasons.
 - Disconnect the cable from the smartphone, and then connect the smartphone again after a few seconds.
 - Restart the smartphone.
 - Turn the ignition switch to OFF and then to ON.

If the error message is still displayed after performing the above action, please contact your dealer or an authorized Pioneer Service Station.

- The time set in this product is not correct.
 - Check if the time is correctly set.

Bluetooth pairing failed. Please pair your Android phone manually.

- The Bluetooth pairing failed for some reasons.
 - Pair this product with the device manually.

To use Android Auto, please stop your car and check your Android phone.

- The default settings are displayed on the screen of the Android Auto compatible device or images are not

- output from the Android Auto compatible device.
- Park your vehicle in a safe place, and follow the instructions displayed on the screen. If the error message is still displayed after performing on-screen instructions, please reconnect the device.

Handling and care of discs

Some basic precautions are necessary when handling your discs.

Built-in drive and care

- Use only conventional, fully circular discs. Do not use shaped discs.
- Do not use cracked, chipped, warped, or otherwise damaged discs as they may damage the built-in drive.
- Use 12-cm discs. Do not use 8-cm discs or an adapter for 8-cm discs.
- When using discs that can be printed on label surfaces, check the instructions and the warnings of the discs. Depending on the discs, inserting and ejecting may not be possible. Using such discs may result in damage to this equipment.
- Do not attach labels, write on or apply chemicals to the surface of the discs.
- Do not attach commercially available labels or other materials to the discs.
- To clean a disc, wipe it with a soft cloth, moving outward from the center.
- Condensation may temporarily impair the built-in drive's performance.
- Playback of discs may not be possible because of disc characteristics, disc format, recorded application, playback environment, storage conditions and so on.
- Road shocks may interrupt disc playback.

- Read the precautions for discs before using them.

Ambient conditions for playing a disc

- At extremely high temperatures, a temperature cutout protects this product by switching it off automatically.
- Despite our careful design of the product, small scratches that do not affect actual operation may appear on the disc surface as a result of mechanical wear, ambient conditions for use or handling of the disc. This is not a sign of the malfunction of this product. Consider it to be normal wear and tear.

Playable discs

DVD-Video



- **DVD** is a trademark of DVD Format/Logo Licensing Corporation.
- It is not possible to play DVD Audio discs. This DVD drive may not be able to play all discs bearing the marks shown above.

CD



AVCHD recorded discs

This unit is not compatible with discs recorded in AVCHD (Advanced Video Codec High Definition) format. Do not insert in AVCHD discs. If inserted, the disc may not be ejected.

Playing DualDisc

- DualDiscs are two-sided discs that have a recordable CD for audio on one side and a recordable DVD for video on the other.
- Playback of the DVD side is possible with this product. However, since the CD side of DualDiscs is not physically compatible with the general CD standard, it may not be possible to play the CD side with this product.
- Frequent loading and ejecting of a DualDisc may result in scratches to the disc.
- Serious scratches can lead to playback problems on this product. In some cases, a DualDisc may become stuck in the disc-loading slot and will not eject. To prevent this, we recommend you refrain from using DualDisc with this product.
- Please refer to the manufacturer for more detailed information about DualDiscs.

Dolby Digital

This product will down-mix Dolby Digital signals internally and the sound will be output in stereo.

- Manufactured under license from Dolby Laboratories. Dolby and the double-D symbol are trademarks of Dolby Laboratories.



Detailed information for playable media

Compatibility

Common notes about disc compatibility

- Certain functions of this product may not be available for some discs.
- Compatibility with all discs is not guaranteed.
- It is not possible to play DVD-RAM discs.
- Playback of discs may become impossible with direct exposure to sunlight, high temperatures, or depending on the storage conditions in the vehicle.

DVD-Video discs

- DVD-Video discs that have incompatible region numbers cannot be played on this DVD drive. The region number of the player can be found on this product's chassis.

DVD-R/DVD-RW/DVD-R SL (Single Layer)/DVD-R DL (Dual Layer) discs

- Unfinalized discs which have been recorded with the Video format (video mode) cannot be played back.
- Discs which have been recorded with the Video Recording format (VR mode) cannot be played back.
- DVD-R DL (Dual Layer) discs which have been recorded with Layer Jump recording cannot be played back.
- For detailed information about recording mode, please contact the manufacturer of media, recorders, or writing software.

CD-R/CD-RW discs

- Unfinalized discs cannot be played back.
- It may not be possible to playback CD-R/CD-RW discs recorded on a music CD recorder or a computer because of disc

- characteristics, scratches or dirt on the disc, or dirt, scratches or condensation on the lens of the built-in drive.
- Playback of discs recorded on a computer may not be possible, depending on the recording device, writing software, their settings, and other environmental factors.
- Please record with the correct format. (For details, please contact manufacturer of media, recorders, or writing software.)
- Titles and other text information recorded on a CD-R/CD-RW disc may not be displayed by this product (in the case of audio data (CD-DA)).
- Read the precautions with CD-R/CD-RW discs before using them.

Common notes about the USB storage device

- Do not leave the USB storage device in any location with high temperatures.
- Depending on the kind of the USB storage device you use, this product may not recognize the storage device or files may not be played back properly.
- The text information of some audio and video files may not be correctly displayed.
- File extensions must be used properly.
- There may be a slight delay when starting playback of files on an USB storage device with complex folder hierarchies.
- Operations may vary depending on the kind of an USB storage device.
- It may not be possible to play some music files from USB because of file characteristics, file format, recorded application, playback environment, storage conditions, and so on.

USB storage device compatibility

- For details about USB storage device compatibility with this product, refer to Specifications (page 126).
- Protocol: bulk

- You cannot connect a USB storage device to this product via a USB hub.
- Partitioned USB storage device is not compatible with this product.
- Firmly secure the USB storage device when driving. Do not let the USB storage device fall onto the floor, where it may become jammed under the brake or gas pedal.
- There may be a slight delay when starting playback of audio files encoded with image data.
- Some USB storage devices connected to this product may generate noise on the radio.
- Do not connect anything other than the USB storage device.

The sequence of audio files on USB storage device.

For USB storage device, the sequence is different from that of USB storage device.

Handling guidelines and supplemental information

- This product is not compatible with the Multi Media Card (MMC).
- Copyright protected files cannot be played back.

Common notes about DivX files

Notes specific to DivX files

- Only DivX files downloaded from DivX partner sites are guaranteed for proper operation. Unauthorized DivX files may not operate properly.
- This product corresponds to a DivX file display of up to 1 590 minutes 43 seconds. Search operations beyond this time limit are prohibited.
- For details on the DivX video versions that can be played on this product, refer to Specifications (page 126).
- For more details about DivX, visit the following site: <http://www.divx.com/>

DivX subtitle files

- Srt format subtitle files with the extension “.srt” can be used.
- Only one subtitle file can be used for each DivX file. Multiple subtitle files cannot be associated.
- Subtitle files that are named with the same character string as the DivX file before the extension are associated with the DivX file. The character strings before the extension must be exactly the same. However, if there is only one DivX file and one subtitle file in a single folder, the files are associated even if the file names are not the same.
- The subtitle file must be stored in the same folder as the DivX file.
- Up to 255 subtitle files may be used. Any more subtitle files will not be recognized.
- Up to 64 characters can be used for the name of the subtitle file, including the extension. If more than 64 characters are used for the file name, the subtitle file may not be recognized.
- The character code for the subtitle file should comply with ISO-8859-1. Using characters other than ISO-8859-1 may cause the characters to be displayed incorrectly.
- The subtitles may not be displayed correctly if the displayed characters in the subtitle file include control code.
- For materials that use a high transfer rate, the subtitles and video may not be completely synchronized.
- If multiple subtitles are programmed to display within a very short time frame, such as 0.1 seconds, the subtitles may not be displayed at the correct time.

Media compatibility chart

General

- Maximum playback time of audio file stored in the disc: 60 h

- Maximum playback time of audio file stored on an USB storage device: 7.5 h (450 minutes)

CD-R/-RW, DVD-R/-R SL/-R DL/DVD-RW

CODEC FORMAT	MP3, WMA, AAC, AVI, MPEG
--------------	--------------------------

USB storage device

CODEC FORMAT	MP3, WMA, WAV, AAC, FLAC, AVI, MPEG-PS, MP4, 3GP, MKV, MOV, ASF, FLV, M4V, MPEG-TS
--------------	--

MP3 compatibility

- Ver. 2.x of ID3 tag is prioritized when both Ver. 1.x and Ver. 2.x exist.
- This product is not compatible with the following: MP3i (MP3 interactive), mp3 PRO, m3u playlist

SAMPLING FREQUENCY	USB: 8 kHz to 48 kHz Disc: 16 kHz to 48 kHz
TRANSMISSION RATE	8 kbps to 320 kbps, (CBR)/VBR
ID3 TAG	USB: ver.1.0/1.1/2.2/ 2.3/2.4 Disc: ver.1.0/1.1/2.2/ 2.3

WMA compatibility

- This product is not compatible with the following: Windows Media™ Audio 9.2 Professional, Lossless, Voice

SAMPLING FREQUENCY	USB: 32 kHz to 48 kHz Disc: 8 kHz to 48 kHz
--------------------	--

TRANSMISSION RATE	USB: 8 kbps to 320 kbps (CBR)/VBR Disc: 5 kbps to 320 kbps (CBR)/VBR
-------------------	---

WAV compatibility

- The sampling frequency shown in the display may be rounded.
- WAV files on the CD-R/-RW, DVD-R/-RW/-R SL/-R DL cannot be played.

SAMPLING FREQUENCY	16 kHz to 48 kHz
--------------------	------------------

AAC compatibility

- This product plays back AAC files encoded by iTunes.

SAMPLING FREQUENCY	USB: 8 kHz to 48 kHz Disc: 8 kHz to 44.1 kHz
TRANSMISSION RATE	USB: 16 kbps to 320 kbps (CBR) Disc: 8 kbps to 320 kbps (CBR)

FLAC compatibility

SAMPLING FREQUENCY	8 kHz to 192 kHz
TRANSMISSION RATE	8 kbps to 24 kbps (CBR)

DivX compatibility

- This product is not compatible with the following: DivX Ultra format, DivX files without video data, DivX files encoded with LPCM (Linear PCM) audio codec
- Depending on the file information composition, such as the number of audio streams, there may be a slight delay in the start of playback on discs.
- If a file contains more than 4 GB, playback stops before the end.

- Some special operations may be prohibited because of the composition of DivX files.
- Files with high transfer rates may not be played back correctly. The standard transfer rate is 4 Mbps for CDs and 10.08 Mbps for DVDs.

CD-R/-RW, DVD-R/-R SL/-R DL/DVD-RW, USB storage device

EXTENSION	USB: .divx, .avi Disc: .divx
MAX RESOLUTION	720 × 576

Video files compatibility (USB)

- Files may not be played back properly depending on the environment in which the file was created or on the contents of the file.
- This product is not compatible with packet write data transfer.
- This product can recognize up to 32 characters, beginning with the first character, including extension for the file and folder name. Depending on the display area, this product may try to display them with a reduced font size. However, the maximum number of the characters that you can display varies according to the width of each character, and of the display area.
- Folder selection sequence or other operations may be altered, depending on the encoding or writing software.
- Regardless of the length of blank section between the songs of original recording, compressed audio files play with a short pause between songs.
- Files may not be able to be played back depending on the bit rate.
- The maximum resolution depends on the compatible video codec.

.avi

Compatible video codec	MPEG4, DivX, H.264, H.263
------------------------	---------------------------

Maximum resolution	1 920 × 1 080
Maximum frame rate	30 fps

.mpg/.mpeg

Compatible video codec	MPEG2
Maximum resolution	720 × 576
Maximum frame rate	30 fps

.divx

Compatible video codec	DivX
Maximum resolution	720 × 576
Maximum frame rate	30 fps

.mp4

Compatible video codec	MPEG4, H.264, H.263
Maximum resolution	1 920 × 1 080
Maximum frame rate	30 fps

.3gp

Compatible video codec	H.263
Maximum resolution	1 920 × 1 080
Maximum frame rate	30 fps

.mkv

Compatible video codec	MPEG4, H.264, VC-1
Maximum resolution	1 920 × 1 080
Maximum frame rate	30 fps

.mov

Compatible video codec	MPEG4, H.264, H.263
Maximum resolution	1 920 × 1 080
Maximum frame rate	30 fps

.flv

Compatible video codec	H.264
Maximum resolution	1 920 × 1 080
Maximum frame rate	30 fps

.wmv/.asf

Compatible video codec	VC-1
------------------------	------

Maximum resolution	1 920 × 1 080
Maximum frame rate	30 fps

.m4v

Compatible video codec	MPEG4, H.264, H.263
Maximum resolution	1 920 × 1 080
Maximum frame rate	30 fps

.ts/.m2ts/.mts

Compatible video codec	MPEG4, H.264, MPEG2
Maximum resolution	1 920 × 1 080
Maximum frame rate	30 fps

Example of a hierarchy**NOTE**

This product assigns folder numbers. The user cannot assign folder numbers.

Bluetooth

The *Bluetooth*® word mark and logos are registered trademarks owned by Bluetooth SIG, Inc. and any use of such marks by PIONEER CORPORATION is under license. Other trademarks and trade names are those of their respective owners.

SiriusXM® Satellite Radio



Sirius, XM and all related marks and logos are trademarks of Sirius XM Radio Inc. All rights reserved.

WMA

Windows Media is either a registered trademark or trademark of Microsoft Corporation in the United States and/or other countries.

- This product includes technology owned by Microsoft Corporation and cannot be used or distributed without a license from Microsoft Licensing, Inc.

FLAC

Copyright © 2000-2009 Josh Coalson
Copyright © 2011-2013 Xiph.Org
Foundation

Redistribution and use in source and binary forms, with or without modification, are permitted provided that the following conditions are met:

- Redistributions of source code must retain the above copyright notice, this list of conditions and the following disclaimer.
- Redistributions in binary form must reproduce the above copyright notice, this list of conditions and the following disclaimer in the documentation and/or other materials provided with the distribution.
- Neither the name of the Xiph.org Foundation nor the names of its

contributors may be used to endorse or promote products derived from this software without specific prior written permission.

THIS SOFTWARE IS PROVIDED BY THE COPYRIGHT HOLDERS AND CONTRIBUTORS "AS IS" AND ANY EXPRESS OR IMPLIED WARRANTIES, INCLUDING, BUT NOT LIMITED TO, THE IMPLIED WARRANTIES OF MERCHANTABILITY AND FITNESS FOR A PARTICULAR PURPOSE ARE DISCLAIMED. IN NO EVENT SHALL THE FOUNDATION OR CONTRIBUTORS BE LIABLE FOR ANY DIRECT, INDIRECT, INCIDENTAL, SPECIAL, EXEMPLARY, OR CONSEQUENTIAL DAMAGES (INCLUDING, BUT NOT LIMITED TO, PROCUREMENT OF SUBSTITUTE GOODS OR SERVICES; LOSS OF USE, DATA, OR PROFITS; OR BUSINESS INTERRUPTION) HOWEVER CAUSED AND ON ANY THEORY OF LIABILITY, WHETHER IN CONTRACT, STRICT LIABILITY, OR TORT (INCLUDING NEGLIGENCE OR OTHERWISE) ARISING IN ANY WAY OUT OF THE USE OF THIS SOFTWARE, EVEN IF ADVISED OF THE POSSIBILITY OF SUCH DAMAGE.

DivX



DivX® Home Theater Certified devices have been tested for high-quality DivX Home Theater video playback (including .avi, .divx). When you see the DivX logo, you know you have the freedom to play your favorite videos.

DivX®, DivX Certified® and associated logos are trademarks of DivX, LLC and are used under license.

This DivX Certified® device can play DivX® Home Theater video files up to 576p (including .avi, .divx).

Download free software at www.divx.com to create, play and cast digital videos.

AAC

AAC is short for Advanced Audio Coding and refers to an audio compression technology standard used with MPEG-2 and MPEG-4. Several applications can be used to encode AAC files, but file formats and extensions differ depending on the application which is used to encode. This unit plays back AAC files encoded by iTunes.

WebLink

WebLink is a trademark of Abalta Technologies, Inc.

Waze

Waze and Waze logo are registered trademarks of Google LLC.

Google, Google Play, Android

Google, Google Play and Android are trademarks of Google LLC.

Android Auto

androidauto

Android Auto is a trademark of Google LLC.

Detailed information regarding connected iPod devices

- Pioneer accepts no responsibility for data lost from an iPod, even if that data is lost while using this product. Please back up your iPod data regularly.
- Do not leave the iPod in direct sunlight for extended amounts of time. Extended exposure to direct sunlight can result in iPod malfunction due to the resulting high temperature.
- Do not leave the iPod in any location with high temperatures.
- Firmly secure the iPod when driving. Do not let the iPod fall onto the floor, where it may become jammed under the brake or gas pedal.
- For details, refer to the iPod manuals.

iPhone, iPod and Lightning®



Use of the Made for Apple badge means that an accessory has been designed to connect specifically to the Apple product(s) identified in the badge, and has been certified by the developer to meet Apple performance standards. Apple is not responsible for the operation of this device or its compliance with safety and regulatory standards. Please note that the use of this accessory with an Apple product may affect wireless performance. iPhone, iPod, iPod nano, iPod touch, and Lightning are trademarks of Apple Inc., registered in the U.S. and other countries.

App Store

App Store is a service mark of Apple Inc.

iOS

iOS is a trademark on which Cisco holds the trademark right in the US and certain other countries.

iTunes

iTunes is a trademark of Apple Inc., registered in the U.S. and other countries.

Apple Music

Apple Music is a trademark of Apple Inc., registered in the U.S. and other countries.

Apple CarPlay



Apple CarPlay is a trademark of Apple Inc. Use of the Works with Apple badge means that an accessory has been designed to work specifically with the technology identified in the badge and has been certified by the developer to meet Apple performance standards.

Siri

Works with Siri through the microphone.

Compatible iPod/iPhone models

- iPhone 7

- iPhone 7 Plus
- iPhone SE
- iPhone 6s
- iPhone 6s Plus
- iPhone 6
- iPhone 6 Plus
- iPhone 5s
- iPhone 5c
- iPhone 5
- iPhone 4s
- iPod touch (6th generation)
- iPod touch (5th generation)
- iPod nano® (7th generation)

Depending on the iPod/iPhone models, it may not be compatible with some AV sources. For details about iPod/iPhone compatibility with this product, refer to the information on our website.

Using app-based connected content

Important

Requirements to access app-based connected content services using this product:

- Latest version of the Pioneer compatible connected content application(s) for the smartphone, available from the service provider, downloaded to your smartphone.
- A current account with the content service provider.
- Smartphone Data Plan.
Note: if the Data Plan for your smartphone does not provide for unlimited data usage, additional charges from your carrier may apply for accessing app-based connected content via 3G, EDGE and/or LTE (4G) networks.
- Connection to the Internet via 3G, EDGE, LTE (4G) or Wi-Fi network.
- Optional Pioneer adapter cable connecting your iPhone to this product.

Limitations:

- Access to app-based connected content will depend on the availability of cellular and/or Wi-Fi network coverage for the purpose of allowing your smartphone to connect to the Internet.
- Service availability may be geographically limited to the region. Consult the connected content service provider for additional information.
- Ability of this product to access connected content is subject to change without notice and could be affected by any of the following: compatibility issues with future firmware versions of smartphone; compatibility issues with future versions of the connected content application(s) for the smartphone; changes to or discontinuation of the connected Content application(s) or service by its provider.
- Pioneer is not liable for any issues that may arise from incorrect or flawed app-based content.
- The content and functionality of the supported applications are the responsibility of the App providers.
- In WebLink, Apple CarPlay and Android Auto, functionality through the product is limited while driving, with available functions determined by the App providers.
- Availability of WebLink, Apple CarPlay and Android Auto functionalities is determined by the App provider, and not determined by Pioneer.
- WebLink, Apple CarPlay and Android Auto allow access to applications other than those listed (subject to limitations while driving), but the extent to which content can be used is determined by the App providers.

Pandora®

Pandora, the Pandora logo, and the Pandora trade dress are trademarks or registered trademarks of Pandora Media, Inc. Used with permission.

Pandora is only available in certain countries. Please visit <http://www.pandora.com/legal> for more information.

Spotify®

SPOTIFY and the Spotify logo are among the registered trademarks of Spotify AB. Compatible mobile digital devices and premium subscription required, where available, see <https://www.spotify.com>.

Notice regarding video viewing

Remember that use of this system for commercial or public viewing purposes may constitute an infringement on the author's rights as protected by the Copyright Law.

Notice regarding DVD-Video viewing

This item incorporates copy protection technology that is protected by U.S. patents and other intellectual property rights of Rovi Corporation. Reverse engineering and disassembly are prohibited.

Notice regarding MP3 file usage

Supply of this product only conveys a license for private, non-commercial use and does not convey a license nor imply any right to use this product in any commercial (i.e. revenue-generating) real time broadcasting (terrestrial, satellite, cable and/or any other media), broadcasting/streaming via internet, intranets and/or other networks or in other electronic content distribution systems, such as pay-audio or audio-on-demand applications. An independent license for such use is required. For details, please visit <http://www.mp3licensing.com>.

Using the LCD screen correctly

Handling the LCD screen

- When the LCD screen is subjected to direct sunlight for a long period of time, it will become very hot, resulting in possible damage to the LCD screen. When not using this product, avoid exposing it to direct sunlight as much as possible.
- The LCD screen should be used within the temperature ranges shown in Specifications on page 126.
- Do not use the LCD screen at temperatures higher or lower than the operating temperature range, because the LCD screen may not operate normally and could be damaged.
- The LCD screen is exposed in order to increase its visibility within the vehicle. Please do not press strongly on it as this may damage it.

- Do not push the LCD screen with excessive force as this may scratch it.
- Never touch the LCD screen with anything besides your finger when operating the touch panel functions. The LCD screen can scratch easily.

Liquid crystal display (LCD) screen

- If the LCD screen is near the vent of an air conditioner, make sure that air from the air conditioner is not blowing on it. Heat from the heater may break the LCD screen, and cool air from the cooler may cause moisture to form inside this product, resulting in possible damage.
- Small black dots or white dots (bright dots) may appear on the LCD screen. These are due to the characteristics of the LCD screen and do not indicate a malfunction.
- The LCD screen will be difficult to see if it is exposed to direct sunlight.
- When using a cellular phone, keep the antenna of the cellular phone away from the LCD screen to prevent disruption of the video in the form of disturbances such as spots or colored stripes.

Maintaining the LCD screen

- When removing dust from or cleaning the LCD screen, first turn this product off and then wipe the screen with a soft dry cloth.
- When wiping the LCD screen, take care not to scratch the surface. Do not use harsh or abrasive chemical cleaners.

LED (light-emitting diode) backlight

A light emitting diode is used inside the display to illuminate the LCD screen.

- At low temperatures, using the LED backlight may increase image lag and degrade the image quality because of the characteristics of the LCD screen. Image quality will improve with an increase in temperature.
- The product lifetime of the LED backlight is more than 10 000 hours. However, it may decrease if used in high temperatures.
- If the LED backlight reaches the end of its product lifetime, the screen will become dimmer and the image will no longer be visible. In that case, please consult your dealer or the nearest authorized Pioneer Service Station.

Specifications

General

Rated power source:

14.4 V DC (10.8 V to 15.1 V allowable)

Grounding system:

Negative type

Maximum current consumption:

10.0 A

Dimensions (W × H × D):

DIN

Chassis:

178 mm × 50 mm × 160 mm (7 in. × 2 in. × 6-1/4 in.)

Nose:

188 mm × 58 mm × 32 mm (7-3/8 in. × 2-1/4 in. × 1-1/4 in.)

D

Chassis:

178 mm × 50 mm × 165 mm (7 in. × 2 in. × 6-1/2 in.)

Nose:

170 mm × 46 mm × 27 mm (6-3/4 in. × 1-3/4 in. × 1 in.)

Weight:

1.9 kg (4.2 lbs)

Display

Screen size/aspect ratio:

7.0 inch wide/16:9 (effective display area: 154.1 mm × 85.9 mm) (6-1/8 in. × 3-3/8 in.)

Pixels:

1 152 000 (2 400 × 480)

Display method:

TFT Active matrix driving

Color system:

PAL/NTSC/PAL-M/PAL-N/SECAM compatible

Temperature range:

-10 °C to +60 °C (+14 °F to +140 °F)

Audio

Maximum power output:

• 50 W × 4

• 50 W × 2 ch/4 Ω + 70 W × 1 ch/2 Ω (for subwoofer)

Continuous power output:

22 W × 4 (50 Hz to 15 kHz, 5 %THD, 4 Ω LOAD, Both Channels Driven)

Load impedance:

4 Ω (4 Ω to 8 Ω [2 Ω for 1 ch] allowable)

Preout output level (max): 4.0 V

Equalizer (13-Band Graphic Equalizer):

Frequency:

50 Hz/80 Hz/125 Hz/200 Hz/315 Hz/
500 Hz/800 Hz/1.25 kHz/2 kHz/3.15
kHz/5 kHz/8 kHz/12.5 kHz

Gain: ±12 dB (2 dB/step)

<Standard Mode>

HPF:

Frequency:

25 Hz/31.5 Hz/40 Hz/50 Hz/63 Hz/80
Hz/100 Hz/125 Hz/160 Hz/200 Hz/250
Hz

Slope:

-6 dB/oct, -12 dB/oct, -18 dB/oct, -24
dB/oct, OFF

Subwoofer/LPF:

Frequency:

25 Hz/31.5 Hz/40 Hz/50 Hz/63 Hz/80
Hz/100 Hz/125 Hz/160 Hz/200 Hz/250
Hz

Slope:
 -6 dB/oct, -12 dB/oct, -18 dB/oct, -24 dB/oct, -30 dB/oct, -36 dB/oct, OFF

Gain:
 +10 dB to -24 dB (1 dB/step)

Phase: Normal/Reverse

Time alignment:
 0 to 140 step (1 inch/step)

Bass boost:
 Gain: +12 dB to 0 dB (2 dB/step)

Speaker level:
 +10 dB to -24 dB (1 dB/step)

<Network Mode>

HPF (High):
 Frequency:
 1.25 kHz/1.6 kHz/2 kHz/2.5 kHz/3.15 kHz/4 kHz/5 kHz/6.3 kHz/8 kHz/10 kHz/12.5 kHz

Slope:
 -6 dB/oct, -12 dB/oct, -18 dB/oct, -24 dB/oct

HPF (Mid):
 Frequency:
 25 Hz/31.5 Hz/40 Hz/50 Hz/63 Hz/80 Hz/100 Hz/125 Hz/160 Hz/200 Hz/250 Hz

Slope:
 -6 dB/oct, -12 dB/oct, -18 dB/oct, -24 dB/oct, OFF

LPF (Mid):
 Frequency:
 1.25 kHz/1.6 kHz/2 kHz/2.5 kHz/3.15 kHz/4 kHz/5 kHz/6.3 kHz/8 kHz/10 kHz/12.5 kHz

Slope:
 -6 dB/oct, -12 dB/oct, -18 dB/oct, -24 dB/oct, OFF

Subwoofer:
 Frequency:
 25 Hz/31.5 Hz/40 Hz/50 Hz/63 Hz/80 Hz/100 Hz/125 Hz/160 Hz/200 Hz/250 Hz

Slope:
 -6 dB/oct, -12 dB/oct, -18 dB/oct, -24 dB/oct, -30 dB/oct, -36 dB/oct, OFF

Gain:
 +10 dB to -24 dB (1 dB/step)

Phase: Normal/Reverse

Time alignment:
 0 to 140 step (1 inch/step)

Bass boost:
 Gain: +12 dB to 0 dB (2 dB/step)

Speaker level:
 +10 dB to -24 dB (1 dB/step)

DVD drive

System:
 DVD-V, VCD, CD, MP3, WMA, AAC, DivX, MPEG player

Usable discs:
 DVD-VIDEO, VIDEO-CD, CD, CD-R, CD-RW, DVD-R, DVD-RW, DVD-R DL

Region number: 1

Signal Format:
 Sampling frequency:
 8 kHz/16 kHz/32 kHz/44.1 kHz/48 kHz

Number of quantization bits:
 16 bit/20 bit/24 bit; linear

Frequency response:
 5 Hz to 22 000 Hz (with DVD, at sampling frequency 48 kHz)

Signal-to-noise ratio:
 91 dB (1 kHz) (IHF-A network) (RCA level)

Output level:
 Video:
 1.0 V p-p/75 Ω (± 0.2 V)

Number of channels: 2 (stereo)

MP3 decoding format:
 MPEG-1 & 2 & 2.5 Audio Layer 3

WMA decoding format:
 Ver. 7, 7.1, 8, 9, 9.1, 9.2 (2 ch audio) (Windows Media Player)

AAC decoding format:
 MPEG-4 AAC (iTunes encoded only):
 .m4a (Ver. 12.5 and earlier)

DivX decoding format:
 Home Theater Ver. 3, 4, 5.2, 6 (Except ultra and HD):
 .avi, .divx

MPEG video decoding format:
MPEG-1, MPEG-2, MPEG-4 (part2), MS-
MPEG-4 (ver. 3)

USB

USB standard spec:

USB 1.1, USB 2.0 full speed, USB 2.0 high speed

Max current supply: 1.5 A

USB Class:

MSC (Mass Storage Class), MTP (Media Transfer Protocol)

File system: FAT16, FAT32, NTFS

<USB audio>

MP3 decoding format:

MPEG-1 & 2 & 2.5 Audio Layer 3

WMA decoding format:

Ver. 7, 7.1, 8, 9, 10, 11, 12 (2 ch audio)
(Windows Media Player)

AAC decoding format:

MPEG-4 AAC (iTunes encoded only) (Ver. 12.5 and earlier)

FLAC decoding format:

Ver. 1.3.0 (Free Lossless Audio Codec)

WAV signal format (MSC Mode only):

Linear PCM

Sampling frequency:

Linear PCM:
16 kHz/22.05 kHz/24 kHz/32 kHz/44.1 kHz/48 kHz

<USB image>

JPEG decoding format (MSC Mode only):

.jpeg, .jpg, .jpe

Pixel Sampling: 4:2:2, 4:2:0

Decode Size:

MAX: 8 192 (H) × 7 680 (W)

MIN: 32 (H) × 32 (W)

PNG decoding format (MSC Mode only):

.png

Decode Size:

MAX: 720 (H) × 576 (W)

MIN: 32 (H) × 32 (W)

BMP decoding format (MSC Mode only):

.bmp

Decode Size:

MAX: 1 920 (H) × 936 (W)

MIN: 32 (H) × 32 (W)

<USB video>

H.264 video decoding format:

Base Line Profile, Main Profile, High Profile

H.263 video decoding format:

Base Line Profile 0/3

VC-1 video decoding format:

Simple Profile, Main Profile, Advanced Profile

DivX:

Home Theater

MPEG4 video decoding format:

Simple Profile, Advanced Simple Profile

MPEG2 video decoding format:

Main Profile

Bluetooth

Version:

Bluetooth 4.1 certified

Output power:

+4 dBm Max. (Power class 2)

Frequency band(s):

2 400 MHz to 2 483.5 MHz

FM tuner

Frequency range:

87.9 MHz to 107.9 MHz

Usable sensitivity:

12 dBf (1.1 μ V/75 Ω , mono, S/N: 30 dB)

Signal-to-noise ratio:

72 dB (IHF-A network)

AM tuner

Frequency range:

530 kHz to 1 710 kHz

Usable sensitivity:

28 μ V (S/N: 20 dB)

Signal-to-noise ratio:

62 dB (IHF-A network)

CEA2006 Specifications



Power output:

14 W RMS \times 4 Channels (4 Ω and \leq 1 % THD+N)

S/N ratio:

91 dBA (reference: 1 W into 4 Ω)

NOTE

Specifications and design are subject to possible modifications without notice due to improvements.

Register your product at

<http://www.pioneerelectronics.com>

in Canada **<http://www.pioneerelectronics.ca>**

PIONEER CORPORATION

28-8, Honkomagome 2-chome, Bunkyo-ku,
Tokyo 113-0021, Japan

PIONEER ELECTRONICS (USA) INC.

P.O. Box 1540, Long Beach, California 90801-1540, U.S.A.
TEL: (800) 421-1404

PIONEER EUROPE NV

Haven 1087, Keetberglaan 1, B-9120 Melsele, Belgium/Belgique
TEL: (0) 3/570.05.11

PIONEER ELECTRONICS ASIACENTRE PTE. LTD.

2 Jalan Kilang Barat, #07-01, Singapore 159346
TEL: 65-6378-7888

PIONEER ELECTRONICS AUSTRALIA PTY. LTD.

5 Arco Lane, Heatherton, Victoria, 3202 Australia
TEL: (03) 9586-6300

PIONEER ELECTRONICS DE MÉXICO S.A. DE C.V.

Bldv. Manuel Ávila Camacho 138, 10 piso
Col.Lomas de Chapultepec, México, D.F. 11000
Tel: 52-55-9178-4270, Fax: 52-55-5202-3714

先鋒股份有限公司

台北市內湖區瑞光路407號8樓
電話：886-(0)2-2657-3588

先鋒電子（香港）有限公司

香港九龍長沙灣道909號5樓
電話：852-2848-6488

© 2019 PIONEER CORPORATION. All rights reserved.

<OPM_AVH3500NEXUC_en_A> UC

DVD RDS AV RECEIVER
RÉCEPTEUR A/V RDS DVD
RADIO AV RDS CON DVD

Pioneer

AVH-3500NEX

Quick start guide
Guide de démarrage rapide
Guía de inicio rápido

English



What's What

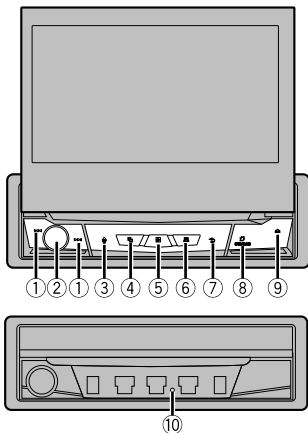



①	⏮ or ⏭	<ul style="list-style-type: none"> Return to the previous track (chapter) or go to the next track (chapter) Perform fast reverse or fast forward Answer or end a call
②	Volume/SRC/OFF	<ul style="list-style-type: none"> Turn to adjust the volume Cycle through all the available sources Turn the source off
③	🗣️	<ul style="list-style-type: none"> Activate the voice recognition mode

④	🏠	<ul style="list-style-type: none"> Switch between the Application screen and the AV operation screen Switch to the camera view mode
⑤	☰	<ul style="list-style-type: none"> Display the top menu screen Power off
⑥	☰	<ul style="list-style-type: none"> Display the menu bar Mute or unmute
⑦	↶	<ul style="list-style-type: none"> Display the top menu screen or back to previous screen Turn off the display
⑧	OPEN/CLOSE	<ul style="list-style-type: none"> Open the LCD panel To close the LCD panel, press again
⑨	▲	<ul style="list-style-type: none"> Eject a disc
⑩	RESET	<ul style="list-style-type: none"> Reset the microprocessor

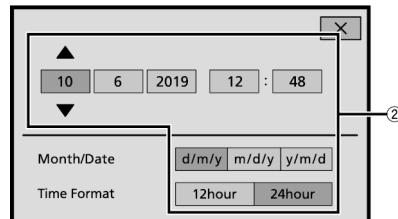
Selecting the clock



- ①  **Switch to clock adjustment display**
- ②  **Adjust the clock**

Selecting the source

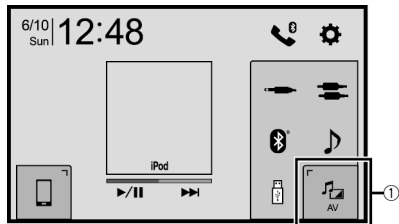







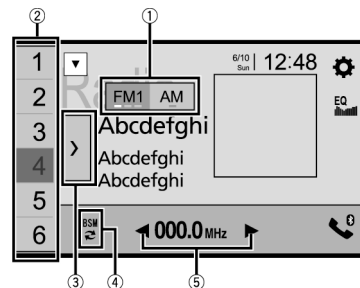

- ①  **Display the AV source selection screen and select a source**



- ①  **Display the source list and select a source**





Tuner operation

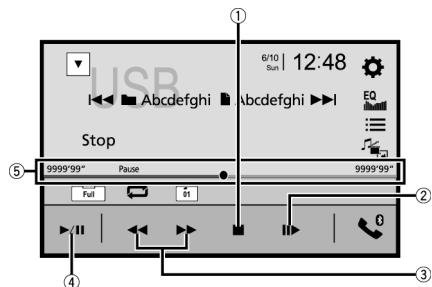

- ①  **Select a band**
- ②  **Recall the preset channel stored to a key from memory**
 **Store the current broadcast frequency to a key**
- ③  **Display the preset channel list**
- ④  **Store the strongest broadcast frequencies**
- ⑤  **Tune into the next station**
 **Start seek turning**





Moving images operation

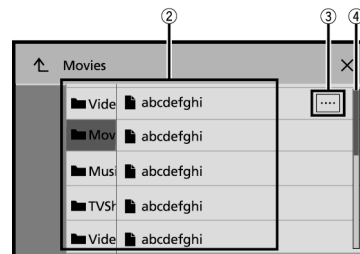

①	 Stop playback
②	 Move ahead one frame
③	 Fast forward and reverse
④	 Pause and start playback
⑤	 Change the playback point

Moving images operation



①	 Display the playlist screen
②	 Select a list title that you want to play
③	 Scroll the list title or category name
④	 Scroll the list

Audio operation

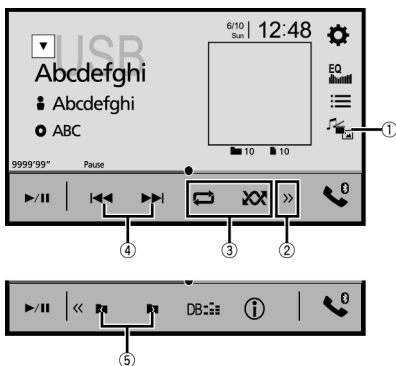

①	Switch between media file types
②	Display the hidden function bar
③	Set the function for playing audio
④	Skip files forward or backward
⑤	Select a folder

Bluetooth telephone operation

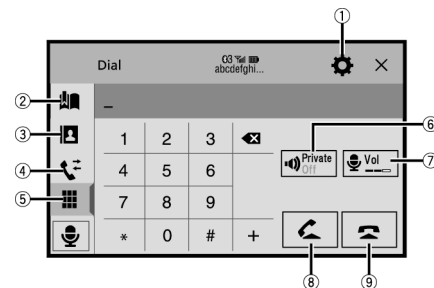

①	Display the Bluetooth connection menu
②	Display the preset dial screen
③	Switch to the phone book mode
④	Switch to the call history list
⑤	Enter the phone number directly
⑥	Turn private mode on and off
⑦	Adjust the listening volume
⑧	Accept an incoming call
⑨	End a call

English

This guide is intended to guide you through the basic functions of this unit.

For details, please refer to the Operation manual stored on the website.

<http://www.pioneerelectronics.com/PUSA/Car>



Français

Ce guide est destiné à vous guider dans les fonctions de base de cet appareil.

Pour les détails, veuillez vous reporter au Mode d'emploi disponible sur le site Web.

<http://www.pioneerelectronics.com/PUSA/Car>



Español

Esta guía tiene como fin explicar las funciones básicas de esta unidad.

Para obtener más información, consulte el manual de operaciones que se encuentra en el sitio web.

<http://www.pioneerelectronics.com/PUSA/Car>



Pioneer

AVH-3500NEX

DVD RDS AV RECEIVER

RÉCEPTEUR A/V RDS DVD

RADIO AV RDS CON DVD

Installation Manual
Manuel d'installation
Manual de instalación

English

Français

Español

Important safety information

⚠ WARNING

Rear visibility systems (backup cameras) are required in certain new vehicles sold in the U.S. and Canada. U.S. regulations began according to a two year phase-in on May 1, 2016, and both the U.S. and Canada require that all such vehicles manufactured on or after May 1, 2018 have rear visibility

systems. **Owners of vehicles equipped with compliant rear visibility systems should not install or use this product in a way that alters or disables that system.** If you are unsure whether your vehicle has a rear visibility system subject to the U.S. or Canadian regulations, please contact the vehicle manufacturer or dealer.

Connection

Precautions

Your new product and this manual

- Do not operate this product, any applications, or the rear view camera option (if purchased) if doing so will divert your attention in any way from the safe operation of your vehicle. Always observe safe driving rules and follow all existing traffic regulations. If you experience difficulty in operating this product, pull over, park your vehicle in a safe location and apply the parking brake before making the necessary adjustments.
- Do not install this product where it may
 - (i) obstruct the driver's vision,
 - (ii) impair the performance of any of the

vehicle's operating systems of safety features, including airbags, hazard lamp buttons, or

- (iii) impair the driver's ability to safely operate the vehicle.

In some cases, it may not be possible to install this product because of the vehicle type or the shape of the vehicle interior.

Important safeguards

⚠ WARNING

Pioneer does not recommend that you install this product yourself. This product is designed for professional installation only. We recommend that only authorized Pioneer service personnel, who have special training and experience in mobile electronics, set up and install this product. **NEVER SERVICE THIS PRODUCT YOURSELF.** Installing or servicing this product and its connecting cables may expose you to the

risk of electric shock or other hazards, and can cause damage to this product that is not covered by warranty.

Precautions before connecting the system

⚠ WARNING

Do not take any steps to tamper with or disable the parking brake interlock system which is in place for your protection. Tampering with or disabling the parking brake interlock system could result in serious injury or death.

⚠ CAUTION

- Secure all wiring with cable clamps or electrical tape. Do not allow any bare wiring to remain exposed.
- Do not directly connect the yellow lead of this product to the vehicle battery. If the lead is directly connected to the battery, engine vibration may eventually cause the insulation to fail at the point where the wire passes from the passenger compartment into the engine compartment. If the yellow lead's insulation tears as a result of contact with metal parts, short-circuiting can occur, resulting in considerable danger.
- It is extremely dangerous to allow cables to become wound around the steering column or shift lever. Be sure to install this product, its cables, and wiring away in such so that they will not obstruct or hinder driving.
- Make sure that the cables and wires will not interfere with or become caught in any of the vehicle's moving parts, especially the steering wheel, shift lever, parking brake, sliding seat tracks, doors, or any of the vehicle's controls.
- Do not route wires where they will be exposed to high temperatures. If the

insulation heats up, wires may become damaged, resulting in a short circuit or malfunction and permanent damage to the product.

- Do not shorten any leads. If you do, the protection circuit (fuse holder, fuse resistor or filter, etc.) may fail to work properly.
- Never feed power to other electronic products by cutting the insulation of the power supply lead of this product and tapping into the lead. The current capacity of the lead will be exceeded, causing overheating.

Before installing this product

- Use this unit with a 12-volt battery and negative grounding only. Failure to do so may result in a fire or malfunction.
- To avoid shorts in the electrical system, be sure to disconnect the (-) battery cable before installation.

To prevent damage

⚠ WARNING

- When speaker output is used by 4 channels, use speakers over 50 W (Maximum input power) and between 4 Ω to 8 Ω (impedance value). Do not use 1 Ω to 3 Ω speakers for this unit.
- When rear speaker output is used by 2 Ω of subwoofer, use speakers over 70 W (Maximum input power).
*Please refer to connection for a connection method.
- The black cable is ground. When installing this unit or power amp (sold separately), make sure to connect the ground wire first. Ensure that the ground wire is properly connected to metal parts of the car's body. The ground wire of the

power amp and the one of this unit or any other device must be connected to the car separately with different screws. If the screw for the ground wire loosens or falls out, it could result in fire generation of smoke or malfunction.

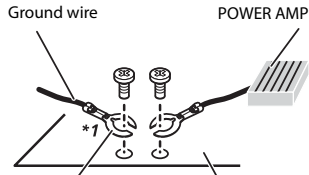

Other devices (Another electronic device in the car) Metal parts of car's body

*1 Non supplied for this unit

- When replacing the fuse, be sure to only use a fuse of the rating prescribed on this product.
- This product cannot be installed in a vehicle without ACC (accessory) position on the ignition switch.

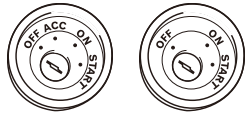

ACC position No ACC position

- To avoid short-circuiting, cover the disconnected lead with insulating tape. It is especially important to insulate all unused speaker leads, which if left uncovered may cause a short circuit.
- For connecting a power amp or other devices to this product, refer to the manual for the product to be connected.
- The graphical symbol  placed on the product means direct current.

Notice for the blue/white lead

- When the ignition switch is turned on (ACC ON), a control signal is output through the blue/white lead. Connect to an external power amp's system remote control terminal, the auto-antenna relay control terminal, or the antenna booster power control terminal (max. 300 mA 12 V DC). The control signal is output through the blue/white lead, even if the audio source is switched off.

This product

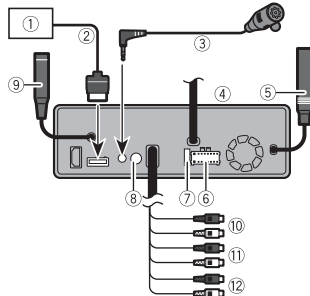

- 1 Pioneer navigation system
Contact your dealer to inquire about the connectable navigation unit.
- 2 RGB cable (supplied with Navigation system)
- 3 Microphone 3 m (9 ft. 10-1/8 in.)
- 4 This product
- 5 Antenna jack
- 6 Power supply
- 7 Fuse (10 A)
- 8 Wired remote input
Hard-wired remote control adapter can be connected (sold separately).

- 9 SiriusXM Connect Vehicle Tuner
Refer to the instruction manual for SiriusXM Connect Vehicle Tuner (sold separately).
- 10 Front output (STD)/High range output (NW)
- 11 Rear output (STD)/Middle range output (NW)
- 12 Subwoofer output (STD)/Low range output (NW)

Power cord

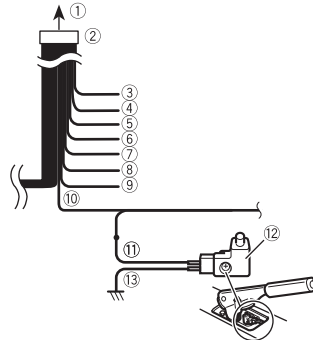

- 1 To power supply
- 2 Power cord
- 3 Yellow
To terminal supplied with power regardless of ignition switch position.
- 4 Red
To electric terminal controlled by ignition switch (12 V DC ON/OFF)
- 5 Orange/white
To lighting switch terminal.
- 6 Black (ground)
To vehicle (metal) body.
- 7 Violet/white
Of the two lead wires connected to the back lamp, connect the one in which

the voltage changes when the gear shift is in the REVERSE (R) position. This connection enables the unit to sense whether the car is moving forward or backward.

- 8 Yellow/black
If you use an equipment with Mute function, wire this lead to the Audio Mute lead on that equipment. If not, keep the Audio Mute lead free of any connections.
- 9 Blue/white
Connect to system control terminal of the power amp (max. 300 mA 12 V DC).
- 10 Light green
Used to detect the ON/OFF status of the parking brake. This lead must be connected to the power supply side of the parking brake switch.
- 11 Power supply side
- 12 Parking brake switch
- 13 Ground side

Speaker leads

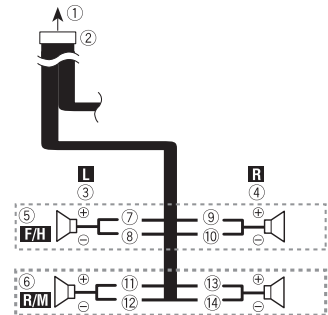

Perform these connections when using a subwoofer without the optional amplifier.

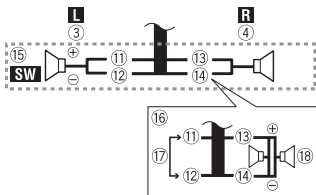

- ① To power supply
- ② Power cord
- ③ Left
- ④ Right
- ⑤ Front speaker (STD) or high range speaker (NW)
- ⑥ Rear speaker (STD) or middle range speaker (NW)
- ⑦ White
- ⑧ White/black
- ⑨ Gray
- ⑩ Gray/black
- ⑪ Green
- ⑫ Green/black
- ⑬ Violet
- ⑭ Violet/black
- ⑮ Subwoofer (4 Ω)
- ⑯ When using a subwoofer of 2 Ω, be sure to connect the subwoofer to the violet and violet/black leads of this unit. Do not connect anything to the green and green/black leads.
- ⑰ Not used.
- ⑱ Subwoofer (4 Ω) × 2

NOTES

- When a subwoofer is connected to this product instead of a rear speaker, change the rear output setting in the initial setting. The subwoofer output of this product is monaural. For details, refer to the Operation Manual.
- With a two-speaker system, do not connect anything to the speaker leads that are not connected to speakers.

Power amp (sold separately)

Without internal amp



Important

The speaker leads are not used when this connection is in use.

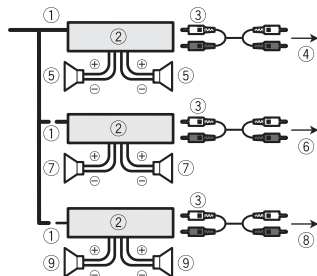

With internal amp



Important

Front speaker and Rear speaker signals (STD) or middle range speaker and high range speaker signals (NW) are output from the speaker leads when this connection is in use.

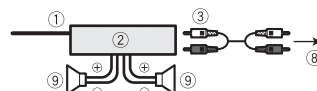

- ① System remote control
Connect to Blue/white cable.
- ② Power amp (sold separately)
- ③ Connect with RCA cable (sold separately)
- ④ To Rear output (STD)
To middle range output (NW)

- ⑤ Rear speaker (STD)
Middle range speaker (NW)
- ⑥ To Front output (STD)
To high range output (NW)
- ⑦ Front speaker (STD)
High range speaker (NW)
- ⑧ To subwoofer output (STD)
To low range output (NW)
- ⑨ Subwoofer (STD)
Low range speaker (NW)

NOTE

Select the appropriate speaker mode between standard mode (STD) and network mode (NW). For details, refer to the Operation Manual.

iPod®/iPhone® and smartphone

NOTES

- For details on how to connect an external device using a separately sold cable, refer to the manual for the cable.
- For details concerning the connection and operations of iPhone or smartphone, refer to the Operation Manual.

iPod/iPhone with Lightning® connector

Connecting via the USB port

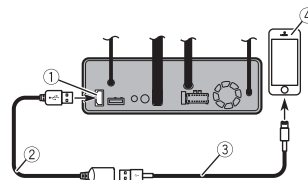

- ① USB port
- ② USB cable 1.5 m (4 ft. 11 in.)
- ③ USB interface cable for iPod/iPhone (CD-IU52) (sold separately)
- ④ iPhone with Lightning connector

iPhone with 30-pin connector

Connecting via the USB port

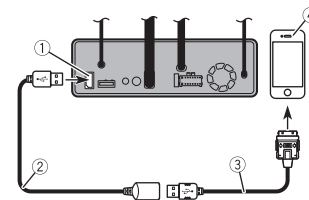

- ① USB port
- ② USB cable 1.5 m (4 ft. 11 in.)
- ③ USB interface cable for iPod/iPhone (CD-IU51) (sold separately)
- ④ iPhone with 30-pin connector

Smartphone (Android™ device)

Connecting via the USB port

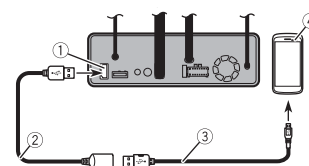

- ① USB port
- ② USB cable 1.5 m (4 ft. 11 in.)
- ③ USB - micro USB cable (Type USB A - micro USB B) (supplied with CD-MU200 (sold separately))
- USB Type-C cable (Type USB A - USB C) (supplied with CD-CU50 (sold separately))
- ④ Smartphone

NOTE

The length of Type USB A - micro USB B cable cannot exceed 2 m (6 ft. 6 in.) and Type USB A - USB C cannot exceed 4 m (13 ft. 1 in.) according to the USB cable standard. When using a cable other than the above conditions, the main unit function may not operate properly.

Camera

About rear view camera

When you use the rear view camera, the rear view image is automatically switched from the video by moving the shift lever to **REVERSE (R)**. **Camera View** mode also allows you to check what is behind you while driving.

WARNING

USE INPUT ONLY FOR REVERSE OR MIRROR IMAGE REAR VIEW CAMERA. OTHER USE MAY RESULT IN INJURY OR DAMAGE.

CAUTION

- The screen image may appear reversed.
- With the rear view camera you can keep an eye on trailers, or back into a tight parking spot. Do not use for entertainment purposes.
- Objects in rear view may appear closer or more distant than in reality.
- The image area of full-screen images displayed while backing or checking the rear of the vehicle may differ slightly.

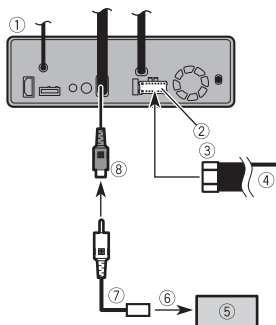

- ① This product
- ② Power supply
- ③ Power cord
- ④ Violet/white (**REVERSE-GEAR SIGNAL INPUT**)
Refer to Power cord on page 3.
- ⑤ Rear view camera (ND-BC8) (sold separately)
- ⑥ To video output
- ⑦ RCA cable (supplied with ND-BC8)
- ⑧ Brown (**REAR VIEW CAMERA IN**)

NOTES

- Connect only the rear view camera to **REAR VIEW CAMERA IN**. Do not connect any other equipment.
- Some appropriate settings are required to use rear view cameras. For details, refer to the Operation Manual.

External video component and the display

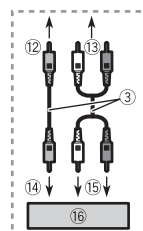
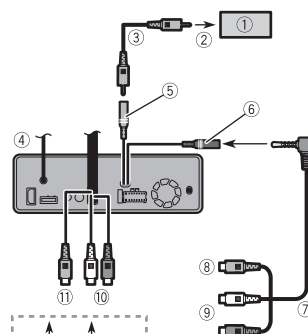

- ① Rear display with RCA input jacks
- ② To video input
- ③ RCA cables (sold separately)
- ④ This product
- ⑤ Yellow (**REAR MONITOR OUTPUT**)
- ⑥ AUX input
- ⑦ Mini-jack AV cable (sold separately)
- ⑧ Yellow
- ⑨ Red, white
- ⑩ Red, white (**AUDIO INPUT, R IN, L IN**)
- ⑪ Yellow (**VIDEO INPUT**)
- ⑫ To Yellow
- ⑬ To Red, white

- ⑭ To video output
- ⑮ To audio outputs
- ⑯ External video component (sold separately)

NOTE

The appropriate setting is required to use the external video component. For details, refer to the Operation Manual.

WARNING

NEVER install the rear display in a location that enables the driver to watch the video source while driving.

This product's rear video output is for connection of a display to enable passengers in the rear seats to watch the video source.

CAUTION

Be sure to use a mini-jack AV cable (sold separately) for wiring. If you use other cables, the wiring position might differ resulting in disturbed images and sounds.

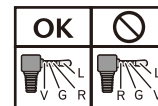

L : Left audio (White)
R : Right audio (Red)
V : Video (Yellow)
G : Ground

Installation

Precautions before installation

⚠ CAUTION

- Never install this product in places where, or in a manner that:
 - Could injure the driver or passengers if the vehicle stops suddenly.
 - May interfere with the driver's operation of the vehicle, such as on the floor in front of the driver's seat, or close to the steering wheel or shift lever.
- To ensure proper installation, be sure to use the supplied parts in the manner specified. If any parts are not supplied with this product, use compatible parts in the manner specified after you have the part compatibility checked by your dealer. If parts other than supplied or compatible ones are used, they may damage internal parts of this product or they may work loose and the product may become detached.
- Do not install this product where it may
 - (i) obstruct the driver's vision,
 - (ii) impair the performance of any of the vehicle's operating systems or safety features, including airbags, hazard lamp buttons or
 - (iii) impair the driver's ability to safely operate the vehicle.
- Never install this product in front of or next to the place in the dashboard, door, or pillar from which one of your vehicle's airbags would deploy. Please refer to your vehicle's owner's manual for reference to the deployment area of the frontal airbags.

Before installing

- Consult with your nearest dealer if installation requires drilling holes or other modifications of the vehicle.
- Before making a final installation of this product, temporarily connect the wiring to confirm that the connections are correct and the system works properly.

Installation notes

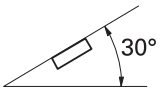
- Do not install this product in places subject to high temperatures or humidity, such as:
 - Places close to a heater, vent or air conditioner.
 - Places exposed to direct sunlight, such as on top of the dashboard.
 - Places that may be exposed to rain, such as close to the door or on the vehicle's floor.
- Install this product horizontally on a surface within 0 to 30 degrees tolerance.
- When installing, to ensure proper heat dispersal when using this unit, make sure you leave ample space behind the rear panel and wrap any loose cables so they are not blocking the vents.

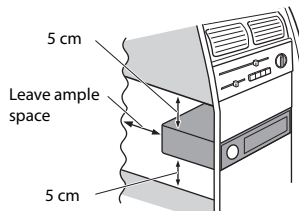

- The cords must not cover up the area shown in the figure below. This is necessary to allow the amplifiers to radiate freely.

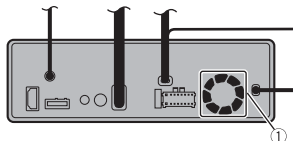

- ① Do not cover this area.
- Make sure you leave enough gap between the dashboard and the LCD panel of this unit so the LCD panel can be opened and closed without contacting with the dashboard.

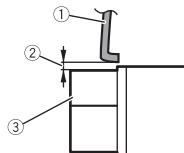

- ① Dashboard
- ② Leave gap
- ③ LCD panel

DIN front/rear-mount

This unit can be properly installed using either front-mount or rear-mount

installation. Use commercially available parts when installing.

DIN Front-mount

1 Decide the position of the side brackets.

When installing in a shallow space, change the position of side brackets (small).

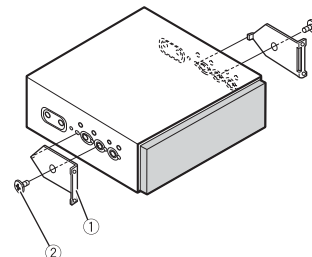

- ① Side bracket (small)
- ② Flush surface screw (5 mm x 6 mm)

2 Install the unit into the dashboard.

Insert the mounting sleeve into the dashboard. And then secure the mounting sleeve by using a screwdriver to bend the metal tabs (90°) into place.

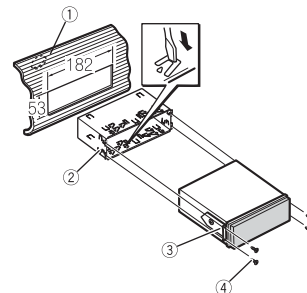

- ① Dashboard
- ② Mounting sleeve
- ③ Side bracket
- ④ Screw (2 mm × 3 mm)

DIN Rear-mount

- 1 Determine the appropriate position where the holes on the bracket and the side of the unit match.

When installing in a shallow space, use the following screw holes.

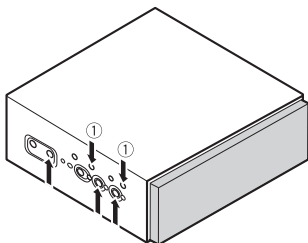

- ① Use binding screws (4 mm × 3 mm) only.

- 2 Tighten two screws on each side.

Use any of binding screws (4 mm × 3 mm), binding screws (5 mm × 6 mm) or flush surface screws (5 mm × 6 mm), depending on the shape of screw holes in the bracket.

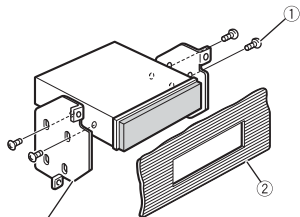

- ① Screw

- ② Dashboard or console
- ③ Factory radio mounting bracket

NOTE

In some types of vehicles, discrepancy may occur between the unit and the dashboard. If this happens, use the supplied frame to fill the gap.

Removing the unit

Extend top and bottom of the trim ring outwards to remove the trim ring. And then loosen the screws (2 mm × 3 mm) to remove the mounting sleeve.

- When reattaching the trim ring, push the trim ring onto the unit until it clicks. (If the trim ring is attached upside down, the trim ring will not fit properly.)

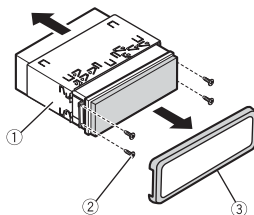

- ① Mounting sleeve
- ② Screw (2 mm × 3 mm)
- ③ Trim ring

Installing the microphone

- Install the microphone in a place where its direction and distance from the driver make it easiest to pick up the driver's voice.
- Be sure to turn off (ACC OFF) the product before connecting the microphone.
- Depending on the vehicle model, the microphone cable length may be too

short when you mount the microphone on the sun visor. In such cases, install the microphone on the steering column.

Mounting on the sun visor

- 1 Fit the microphone lead into the groove.

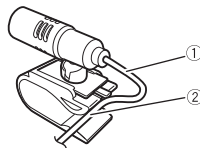

- ① Microphone lead
- ② Groove

- 2 Attach the microphone clip to the sun visor.

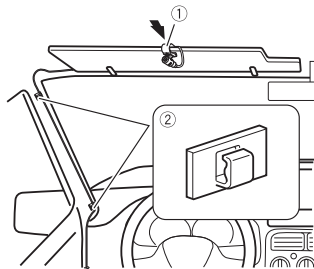

- ① Microphone clip
- ② Clamps

Use separately sold clamps to secure the lead where necessary inside the vehicle.

Install the microphone on the sun visor when it is in the up position. It cannot recognise the driver's voice if the sun visor is in the down position.

Installation on the steering column

- 1 Detach the microphone base from the microphone clip by sliding the microphone base while pressing the tab.

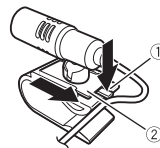

- ① Tab
- ② Microphone base

- 2 Mount the microphone on the steering column.

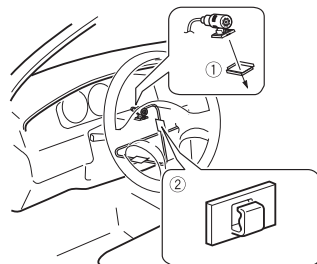

- ① Double-sided tape
- ② Clamps

Use separately sold clamps to secure the lead where necessary inside the vehicle.

NOTE

Install the microphone on the steering column, keeping it away from the steering wheel.

Adjusting the microphone angle

The microphone angle can be adjusted.



PIONEER CORPORATION

28-8, Honkomagome 2-chome, Bunkyo-ku,
Tokyo 113-0021, Japan

PIONEER ELECTRONICS (USA) INC.

P.O. Box 1540, Long Beach, California 90801-1540, U.S.A.
TEL: (800) 421-1404

PIONEER EUROPE NV

Haven 1087, Keetberglaan 1, B-9120 Melsele, Belgium/Belgique
TEL: (0) 3/570.05.11

PIONEER ELECTRONICS ASIACENTRE PTE. LTD.

2 Jalan Kilang Barat, #07-01, Singapore 159346
TEL: 65-6378-7888

PIONEER ELECTRONICS AUSTRALIA PTY. LTD.

5 Arco Lane, Heatherton, Victoria, 3202 Australia
TEL: (03) 9586-6300

PIONEER ELECTRONICS DE MÉXICO S.A. DE C.V.

Blvd. Manuel Ávila Camacho 138, 10 piso
Col.Lomas de Chapultepec, México, D.F. 11000
Tel: 52-55-9178-4270, Fax: 52-55-5202-3714

先鋒股份有限公司

台北市內湖區瑞光路407號8樓
電話：886-(0)2-2657-3588

先鋒電子（香港）有限公司

香港九龍長沙灣道909號5樓
電話：852-2848-6488